

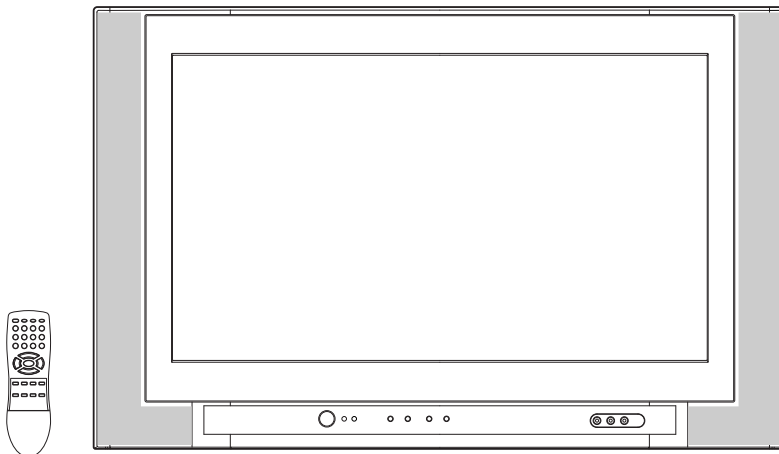

OWNER'S MANUAL

26" WIDE FLAT DIGITAL TELEVISION

HDTV2600



ATTENTION

If you purchase a universal remote control from your local retailer, please contact the remote manufacturer for the required programming code.

TV/CABLE MODE SELECTION

When shipped from the factory, the TV/CABLE menu option is set to the "CABLE" (Cable Television) mode. If not using Cable TV, set this menu option to the "TV" position.

IF CONTACT WITH CUSTOMER SERVICE IS REQUIRED
PLEASE HAVE THE MODEL NUMBER READY PRIOR TO THE CALL
CUSTOMER SERVICE – 1-800-289-0980

ORION WEBSITE

FOR INFORMATION ON OUR OTHER PRODUCTS, PLEASE VISIT OUR WEBSITE AT

www.orionsalesinc.com

Before operating the unit, please read this manual thoroughly.



The lightning flash with arrowhead symbol, within an equilateral triangle is intended to alert the user to the presence of uninsulated dangerous voltage within the product's enclosure that may be of sufficient magnitude to constitute a risk of electric shock.



The exclamation point within an equilateral triangle is intended to alert the user to the presence of important operating and maintenance (servicing) instructions in the literature accompanying the appliance.

CAUTION: Changes or modifications not expressly approved by the party responsible for compliance with the FCC Rules could void the user's authority to operate this equipment.

WARNING: TO PREVENT FIRE OR SHOCK HAZARD, DO NOT EXPOSE THIS APPLIANCE TO RAIN OR MOISTURE.

IMPORTANT SAFEGUARDS

1. READ INSTRUCTIONS

All the safety and operating instructions should be read before the unit is operated.

2. RETAIN INSTRUCTIONS

The safety and operating instructions should be retained for future reference.

3. HEED WARNINGS

All warnings on the unit and in the operating instructions should be adhered to.

4. FOLLOW INSTRUCTIONS

All operating and use instructions should be followed.

5. CLEANING

Unplug this unit from the wall outlet before cleaning. Do not use liquid cleaners or aerosol cleaners. Use a damp cloth for cleaning the exterior cabinet only.

6. ATTACHMENTS

The manufacturer of this unit does not make any recommendations for attachments, as they may cause hazards.

7. WATER AND MOISTURE

Do not use this unit near water. For example, near a bathtub, washbowl, kitchen sink, laundry tub, in a wet basement, or near a swimming pool.

8. ACCESSORIES

Do not place this unit on an unstable cart, stand, tripod, bracket, or table.

The unit may fall, causing serious injury, and serious damage to the unit.

8A. An appliance and cart combination should be moved with care. Quick stops, excessive force, and uneven surfaces may cause the appliance and cart combination to overturn.

PORTABLE CART WARNING
(symbol provided by RETAC)



9. VENTILATION

Slots and openings in the cabinet back or bottom are provided for ventilation, to ensure reliable operation of the unit and to protect it from overheating. These openings must not be blocked or covered. The openings should never be blocked by placing the unit on a bed, sofa, rug, or other similar surface. This unit should never be placed near or over a radiator or heat source. This unit should not be placed in a built-in installation, such as a bookcase, or rack unless proper ventilation is provided or the manufacturer's instructions have been adhered to.

10. POWER SOURCE

This unit should be operated only from the type of power source indicated on the rating plate. If you are not sure of the type of power supply to your home, consult your appliance dealer or local power company. For units intended to operate from battery power, or other sources, refer to the operating instructions.

11. GROUNDING OR POLARIZATION

This unit is equipped with a polarized alternating current line plug (a plug having one blade wider than the other). This plug will fit into the power outlet only one way. This is a safety feature. If you are unable to insert the plug fully into the outlet, try reversing the plug. If the plug should still fail to fit, contact your electrician to replace your obsolete outlet. Do not defeat the safety purpose of the polarized plug. If your unit is equipped with a 3-wire grounding-type plug, a plug having a third (grounding) pin, this plug will only fit into a grounding-type power outlet. This too, is a safety feature. If you are unable to insert the plug into the outlet, contact your electrician to replace your obsolete outlet. Do not defeat the safety purpose of the grounding-type plug.

12. POWER-CORD PROTECTION

Power-supply cords should be routed so that they are not likely to be walked on or pinched by items placed upon or against them, paying particular attention to cords at plugs, convenience receptacles, and the point where they exit from the appliance.

13. LIGHTNING

To protect your unit during a lightning storm, or when it is left unattended and unused for long periods of time, unplug it from the wall outlet and disconnect the antenna or cable system. This will prevent damage to the unit due to lightning and power line surges.

14. POWER LINES

An outside antenna system should not be located in the vicinity of overhead power lines, other electric light or power circuits, or where it can fall into such power lines or circuits. When installing an outside antenna system, extreme care should be taken to keep from touching such power lines or circuits as contact with them might be fatal.

15. OVERLOADING

Do not overload wall outlets and extension cords as this can result in a risk of fire or electric shock.

16. OBJECT AND LIQUID ENTRY

Do not push objects through any openings in this unit as they may touch dangerous voltage points or short out parts that could result in fire or electric shock. Never spill or spray any type of liquid into the unit.

17. OUTDOOR ANTENNA GROUNDING

If an outside antenna or cable system is connected to the unit, be sure the antenna or cable system is grounded to provide some protection against voltage surges and built-up static charges. Section 810 of the National Electrical Code, ANSI/NFPA 70, provides information with respect to proper grounding of the mast and supporting structure, grounding of the lead-in wire to an antenna discharge unit, size of grounding conductors, location of antenna discharge unit, connection to grounding electrodes, and requirements for the grounding electrode.

18. SERVICING

Do not attempt to service this unit yourself as opening or removing covers may expose you to dangerous voltage or other hazards. Refer all servicing to qualified service personnel.

19. DAMAGE REQUIRING SERVICE

Unplug this unit from the wall outlet and refer servicing to qualified service personnel under the following conditions:

- a. When the power-supply cord or plug is damaged.
- b. If liquid has been spilled, or objects have fallen into the unit.
- c. If the unit has been exposed to rain or water.
- d. If the unit does not operate normally by following the operating instructions. Adjust only those controls that are covered by the operating instructions, as an improper adjustment of other controls may result in damage and will often require extensive work by a qualified technician to restore the unit to its normal operation.
- e. If the unit has been dropped or the cabinet has been damaged.
- f. When the unit exhibits a distinct change in performance, this indicates a need for service.

20. REPLACEMENT PARTS

When replacement parts are required, be sure the service technician uses replacement parts specified by the manufacturer or those that have the same characteristics as the original part.

Unauthorized substitutions may result in fire, electric shock or other hazards.

21. SAFETY CHECK

Upon completion of any service or repairs to this unit, ask the service technician to perform safety checks to determine that the unit is in proper operating condition.

22. HEAT

The product should be situated away from heat sources such as radiators, heat registers, stoves, or other products (including amplifiers) that produce heat.

23. NOTE TO CATV SYSTEM INSTALLER

This reminder is provided to call the CATV system installer's attention to Article 820-40 of the NEC that provides guidelines for proper grounding and, in particular, specifies that the cable ground shall be connected to the grounding system of the building, as close to the point of cable entry as practical.

EXAMPLE OF ANTENNA GROUNDING AS PER NATIONAL ELECTRICAL CODE

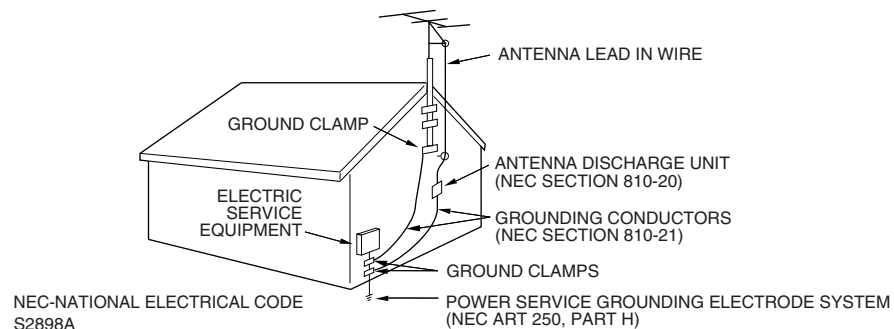

Contents

PREPARATIONS	
IMPORTANT SAFEGUARDS	2
Contents	4
Features	5
Power source	5
Parts and functions	6
Remote control	7
Antenna connections	8
Cable TV connections	9
Connections to other equipment	10
Starting setup	15
Setting the language	16
Memorizing channels	17
Setting your favorite channels	19
OPERATION	
TV operation	20
Setting the V-Chip	22
Setting the front panel lock	25
Labeling channels	26
Labeling the video input source	27
Setting the clock	28
Setting the on timer	29
Setting the off timer	30
Setting the picture size	31
Setting the picture scroll	33
Adjusting the picture preference	34
Picture control adjustment	35
Selecting the color temperature	36
Selecting the Scan Velocity Modulation (SVM)	36
Resetting your picture adjustment	36
Closed Caption	37
CC advanced	38
Selecting stereo	39
Second Audio Program (SAP)	39
Sound control adjustment	39
Selecting the BBE	40
Selecting the digital output	40
Selecting the audio language	41
Resetting your audio adjustment	41
Checking the Digital-signal strength	42
OTHERS	
Troubleshooting	43
Specifications	44
LIMITED WARRANTY	45

Features

High Quality Picture Horizontal Resolution More than 500 lines. It exceeds Super VHS (400 lines) or Laser Disc (430 lines) in resolution.

Compatible with a wide range of audio outputs Digital Audio Jack (Coaxial) - When a component with a built-in Dolby Digital decoder is connected, Dolby Digital sound can produce the effect of being in a movie theater or a concert hall.

- **Integrated Digital Tuner** - You can view a digital broadcasting without using Digital TV Set-Top Box.
- **Closed Caption Decoder With Full Text Mode** - Displays text captions or full screen text on the screen for hearing impaired viewers.
- **Picture Adjustments Using The Remote Control** - The On-Screen display allows precise remote control adjustment of BRIGHTNESS, CONTRAST, COLOR, TINT and SHARPNESS.
- **Programmable TV Sleep Timer** - Operable from the remote control, the TV can be programmed up to 120 minutes to turn off automatically.
- **V-Chip** - The V-Chip function can read the rating of a TV program or movie content if the program is encoded with this information. V-chip will allow you to set a restriction level.
- **Stereo/SAP Reception** - This TV is designed to receive stereo and second audio program (SAP) broadcasts where available.
- **BBE** - BBE gives you vivid sound with incredible presence.
- **2 sets of S-Video/Component Video jacks** - A VCR, DVD player, satellite receiver or other audio/video component can be connected to this unit.
- **Video Input Jacks** - This unit is equipped 3 types of video input jacks. The component video in jacks and S-video in jack enable you to watch the DVD player or the video devices with high quality picture.
- **On-Screen 3 Language Display** - You can select one of 3 languages, English, Spanish or French for on-screen programming.

* Manufactured under license from Dolby Laboratories. "Dolby" and the double-D symbol are trademarks of Dolby Laboratories.

Power source

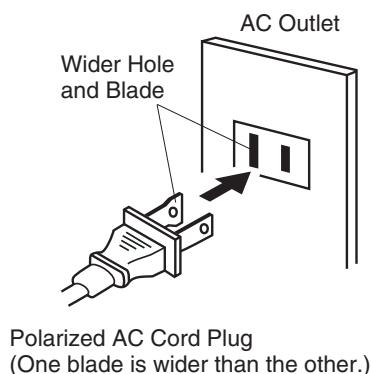

TO USE AC POWER SOURCE

Use the AC polarized line cord provided for operation on AC. Insert the AC cord plug into a standard 120V 60Hz polarized AC outlet.

NOTES:

- Never connect the AC line cord plug to other than the specified voltage (120V 60Hz). Use the attached power cord only.
- If the polarized AC cord does not fit into a non-polarized AC outlet, do not attempt to file or cut the blade. It is the user's responsibility to have an electrician replace the obsolete outlet.
- If you cause a static discharge when touching the unit and the unit fails to function, simply unplug the unit from the AC outlet and plug it back in. The unit should return to normal operation.

Parts and functions

Front

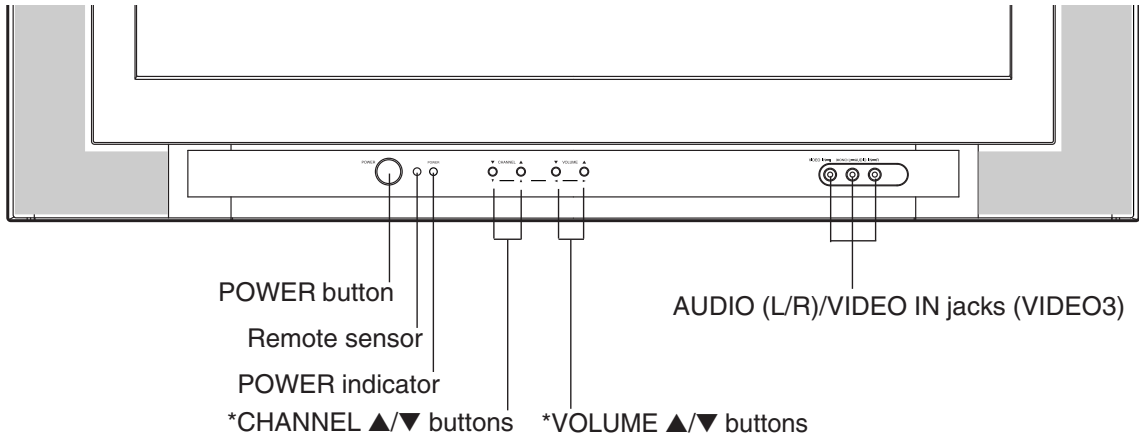

* To display the menu screen.

Press both VOLUME ▲/▼ buttons at the same time to display the menu screen.

CHANNEL ▲/▼ buttons and VOLUME ▲/▼ buttons can be used to select the desired setting during the menu screen operations.

Rear

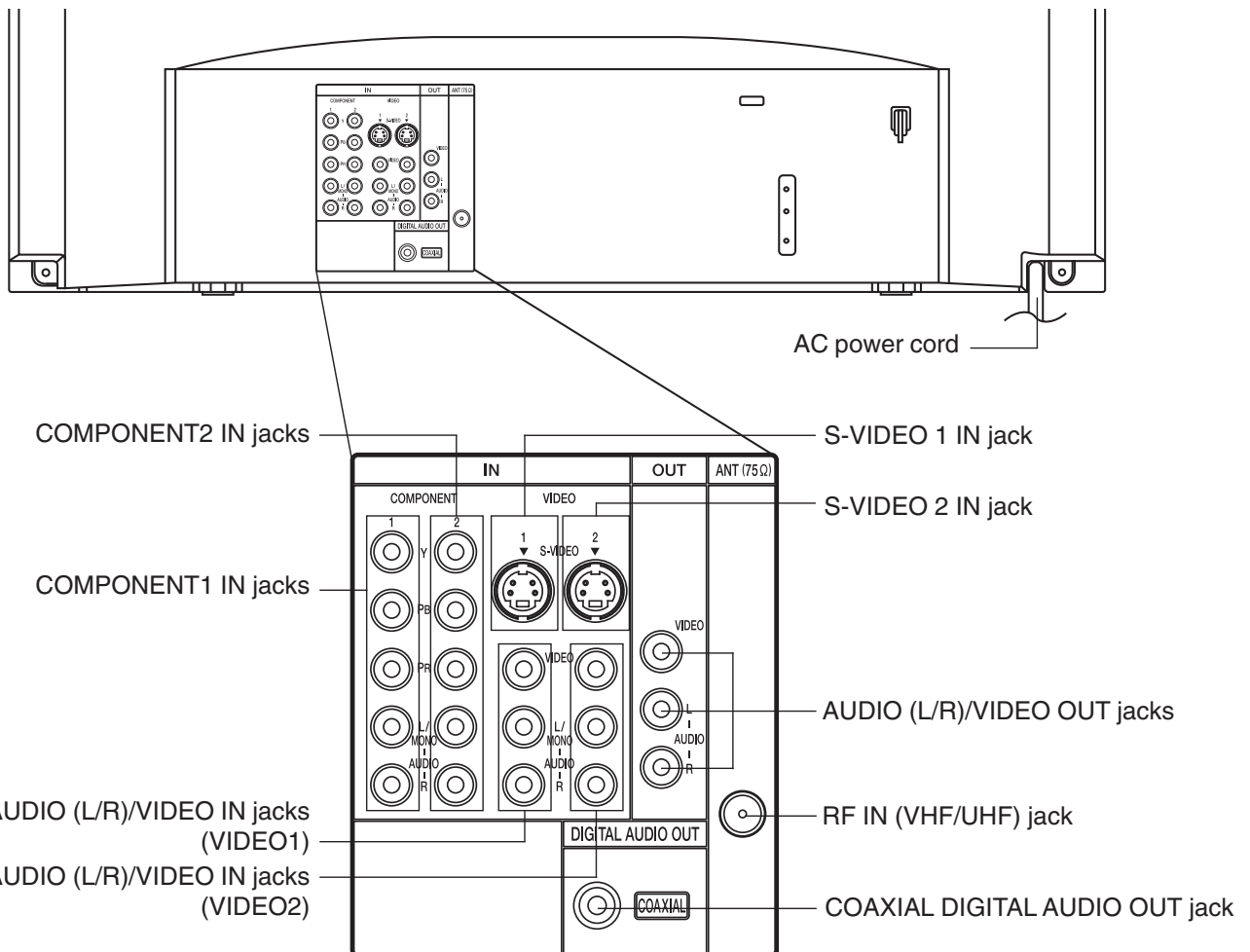

Remote control

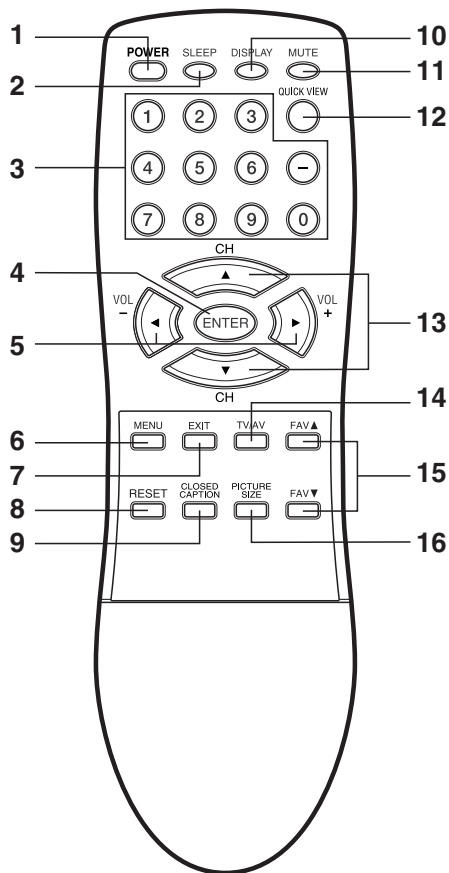

1. **POWER button** - Press to turn the TV on. Press again to turn the TV off.
2. **SLEEP button** - To set the TV to turn off after a preset amount of time, press this button.
3. **Direct Channel Selection buttons (0-9)** - Allows direct access to any channel. The “-” button is used to select digital channels.

4. **ENTER button** - Press to enter or select information for menu screen operations.
5. **VOL (VOLUME) + / - buttons** - Press the + button to increase, or the - button to decrease the volume level. Use to select the desired setting during the menu screen operation.
6. **MENU button** - Press to display the menu screen function.
7. **EXIT button** - Press to exit from the menu screen.
8. **RESET button** - Press to reset the menu screen picture and sound adjustments to their factory preset positions, while in the adjustment menu.
9. **CLOSED CAPTION button** - Press this button to display CLOSED CAPTION menu.
10. **DISPLAY button** - When TV receives an analog signal and press this button, the current information will appear in the screen. When TV receives a digital signal, press once, the digital information will appear. Press twice, the analog information will appear. To remove display from the screen, press again.
11. **MUTE button** - To turn off the sound, press this button once. The TV will be silenced and the symbol “MUTE” will appear on the screen. The muting feature can be released by pressing the MUTE button again or one of the VOL + or - buttons.
12. **QUICK VIEW button** - This button allows you to go back to the previous channel selected by pressing the QUICK VIEW button. Press this button again to return to the channel you were watching.
13. **CH (CHANNEL) ▲ / ▼ buttons** - Press the ▲ button to change to a higher numbered channel set into memory. Press the ▼ button to change to a lower numbered channel set into memory. Use to select the desired setting during the menu screen operation.
14. **TV/AV button** - Press this button to display SOURCE SELECTION menu to select the video input source.
15. **FAV ▲ / ▼ buttons** - Press to select your favorite channels.
16. **PICTURE SIZE button** - Press this button to display PICTURE SIZE menu.

Before using the remote control, batteries must first be installed.

HOW TO INSTALL BATTERIES

1. Open the battery compartment cover.

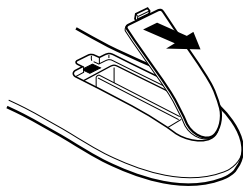

2. Install two “AAA” batteries (not supplied).

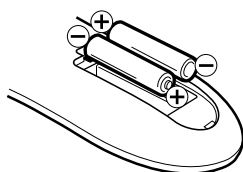

3. Replace the battery compartment cover.

Use two “AAA” size batteries. The batteries may last approximately one year depending on how much the remote control is used. For best performance, it is recommended that batteries should be replaced on a yearly basis, or when the remote operation becomes erratic. Do not mix old and new batteries or different types.

BATTERY PRECAUTIONS

These precautions should be followed when using batteries in this device:

- Use only the size and type of batteries specified.
- Be sure to follow the correct polarity when installing the batteries as indicated in the battery compartment. Reversed batteries may cause damage to the device.
- Do not mix different types of batteries together (e.g. Alkaline and Carbon-zinc) or old batteries with fresh ones.
- If the device is not to be used for a long period of time, remove the batteries to prevent damage or injury from possible battery leakage.
- Do not try to recharge batteries not intended to be recharged; they can overheat and rupture (follow battery manufacturer’s directions).

Antenna connections

If you are using an indoor or outdoor antenna, follow the instructions below that correspond to your antenna system. If you are using a cable TV service (CABLE), see page 9 for Cable TV connections.

Combination VHF/UHF Antenna (Single 75 ohm Cable or 300 ohm Twin-lead Wire)

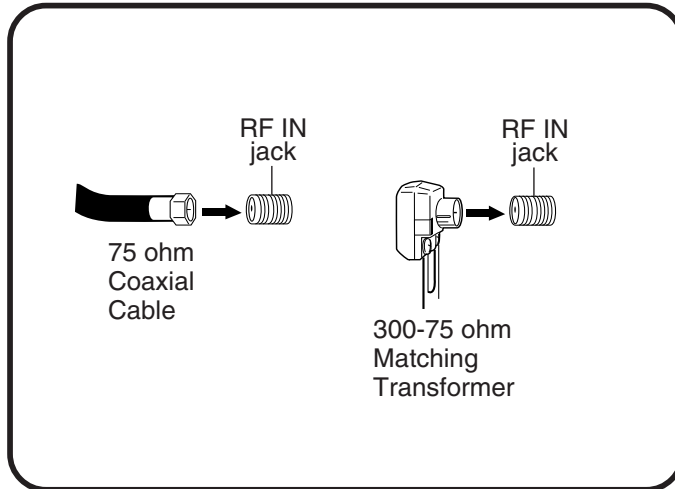

Connect the 75 ohm Cable from the Combination VHF/UHF Antenna to the RF IN Jack.

If your Combination VHF/UHF Antenna has a 300 ohm Twin-lead Wire, the use of the 300-75 ohm Matching Transformer may be necessary.

Combination VHF/UHF Antenna (Separate VHF and UHF 300 ohm Twin-lead Wires)

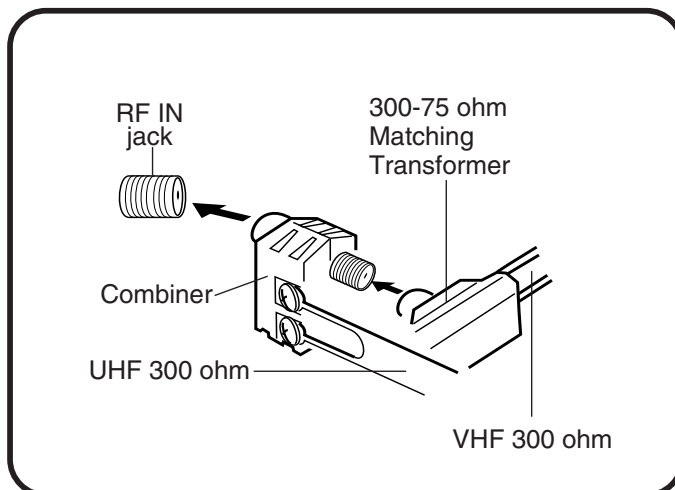

Connect the UHF 300 ohm Twin-lead Wire to the Combiner (not supplied). Connect the VHF 300 ohm Twin-lead Wire to the 300-75 ohm Matching Transformer. Attach the Transformer to the Combiner, then attach the Combiner to the RF IN Jack.

Separate VHF/UHF Antennas (75 ohm VHF Cable and 300 ohm UHF Twin-lead Wires)

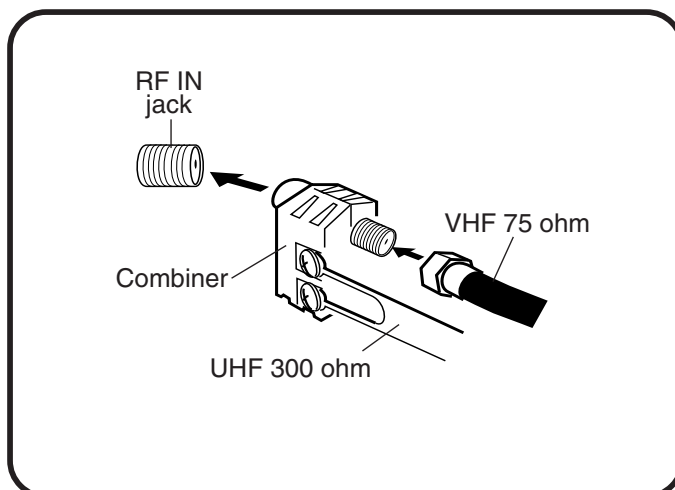

Connect the VHF 75 ohm cable and UHF 300 ohm Twin-lead Wire to the Combiner. Attach the Combiner to the RF IN Jack.

Cable TV connections

This unit has an extended tuning range and can tune most cable channels without using a Cable TV Converter box. Some Cable TV companies offer “premium pay channels” in which the signal is scrambled. Descrambling these signals for normal viewing requires the use of a descrambler device which is generally provided by the Cable TV company.

FOR SUBSCRIBERS TO BASIC CABLE TV SERVICE

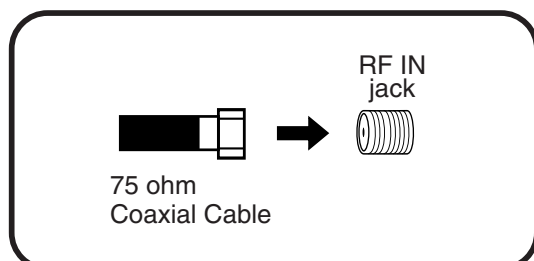

For basic cable service not requiring a Converter/Descrambler box, connect the 75 ohm Coaxial Cable directly to the RF IN Jack on the back of the unit.

FOR SUBSCRIBERS TO SCRAMBLED CABLE TV SERVICE

If you subscribe to a Cable TV service which requires the use of a Converter/Descrambler box, connect the incoming 75 ohm Coaxial Cable to the Converter/Descrambler box. Using another 75 ohm Coaxial Cable, connect the output jack of the Converter/Descrambler box to the RF IN Jack on the unit. Follow the connections shown below. Set the unit to the output channel of the Converter/Descrambler box (usually channel 3 or 4) and use the Converter/Descrambler box to select channels.

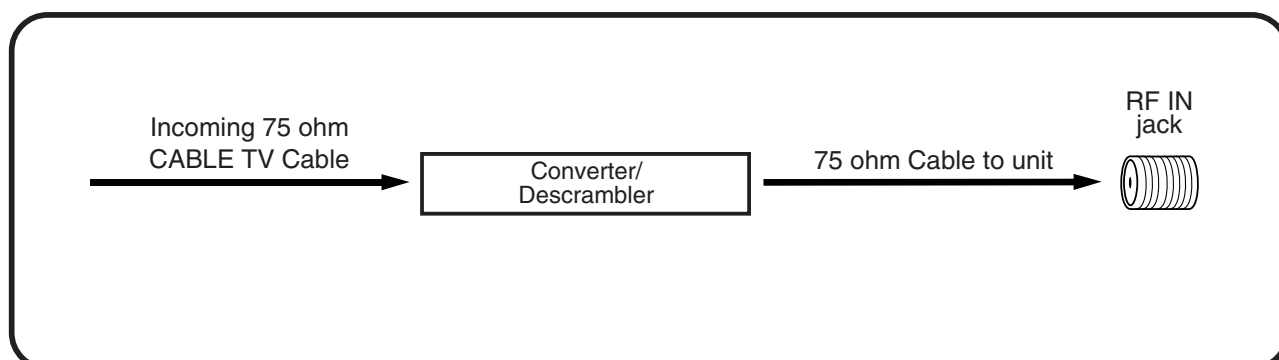

FOR SUBSCRIBERS TO UNSCRAMBLED BASIC CABLE TV SERVICE WITH SCRAMBLED PREMIUM CHANNELS

If you subscribe to a Cable TV service in which basic channels are unscrambled and premium channels require the use of a Converter/Descrambler box, you may wish to use a signal Splitter and an A/B Switch box (available from the Cable TV company or an electronics supply store). Follow the connections shown below. With the switch in the “B” position, you can directly tune any unscrambled channels on your unit. With the switch in the “A” position, tune your unit to the output of the Converter/Descrambler box (usually channel 3 or 4) and use the Converter/Descrambler box to tune scrambled channels.

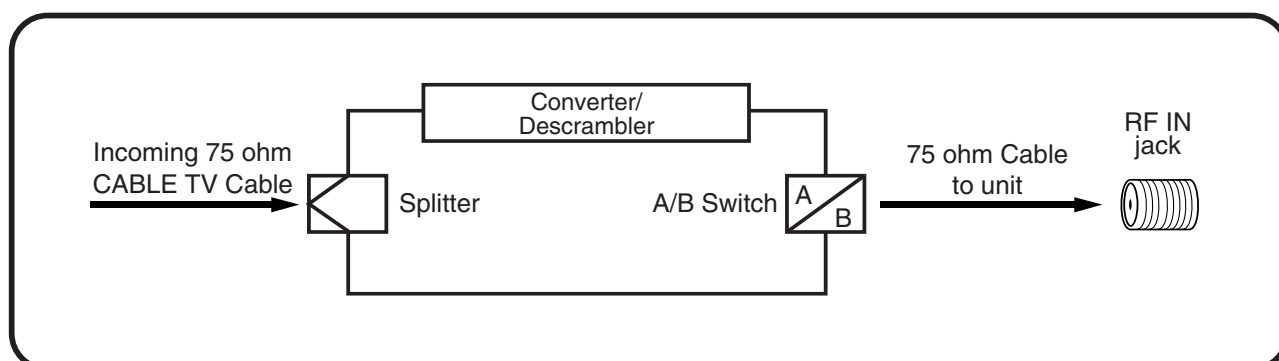

Connections to other equipment

The exact arrangement you use to interconnect various video and audio components to the TV is dependent on the model and features of each component. Check the Owner's Manual provided with each component for the location of video and audio inputs and outputs.

The connection diagrams below are offered as suggestions. You may need to modify them to accommodate your particular assortment of components. The diagrams are intended to show component video and audio interconnections only.

Selecting the video input source

Press **TV/AV** to view a signal from another device connected to your TV, such as a VCR or DVD player. You can select ANT, VIDEO1, VIDEO2, VIDEO3 (on the front panel), COMPONENT1, or COMPONENT2 depending on which input jacks you used to connect your devices.

Pressing **TV/AV** on the remote control displays the current signal source (press **TV/AV** again or **0-5** to change).

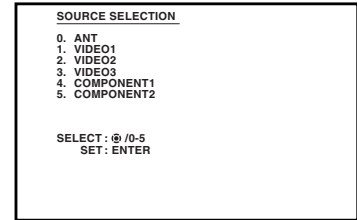

To connect the TV to a VCR

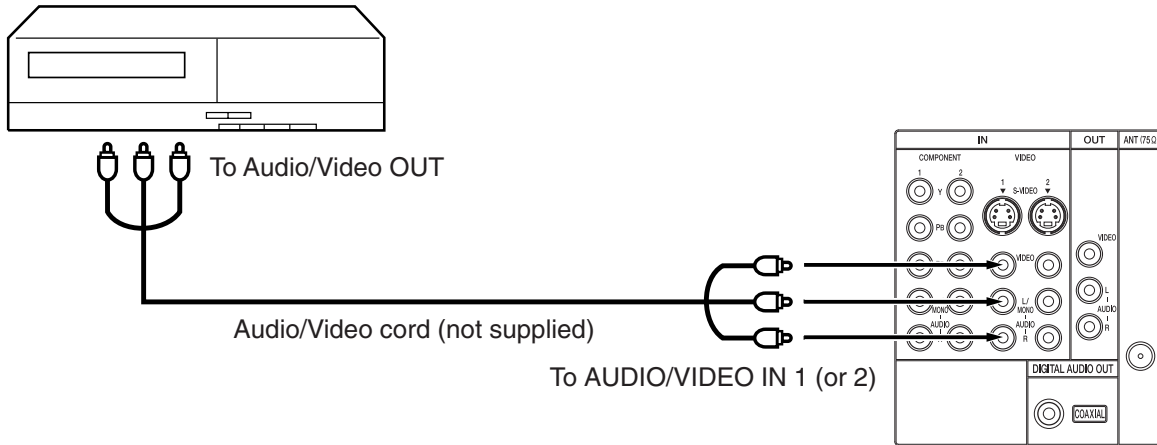

Rear of the TV

To connect the TV to a VCR with an S-Video cord

If you connect a VCR with a S-VIDEO cord to the S-VIDEO IN jack on the rear of the TV, you must also connect the audio cords to the AUDIO IN jacks on the rear of the TV. The S-VIDEO cord only carries the video signal. The audio signal is separate.

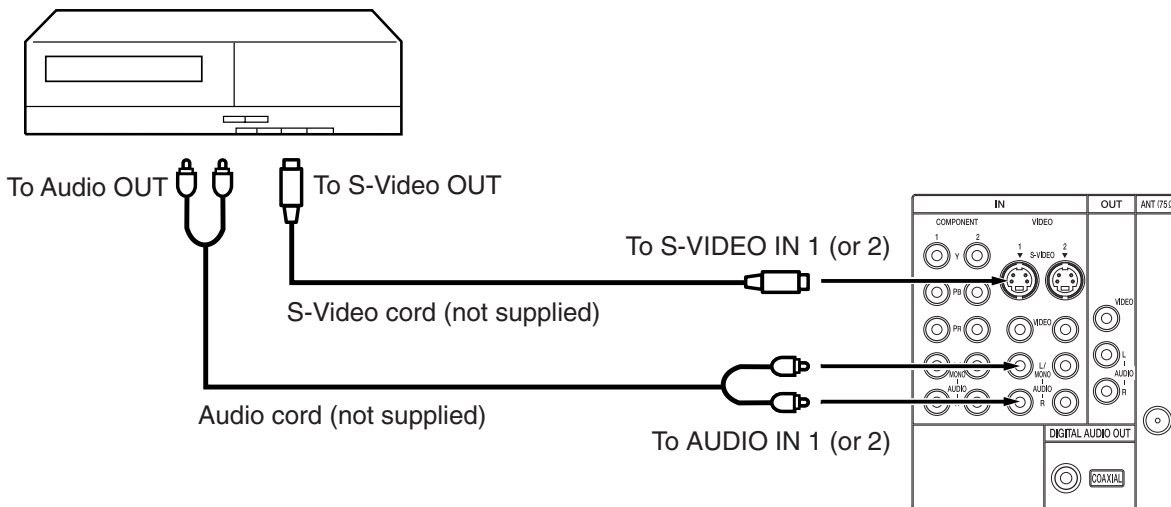

Rear of the TV

NOTE:

When the S-video cord and the video cord are connected to each jack at the same time, the S-video cord takes precedence over the video cord.

Connections to other equipment

(continued)

To connect the TV to a DVD player/Satellite receiver

If your DVD player or Satellite receiver has a S-Video out jack, connect cords as shown.

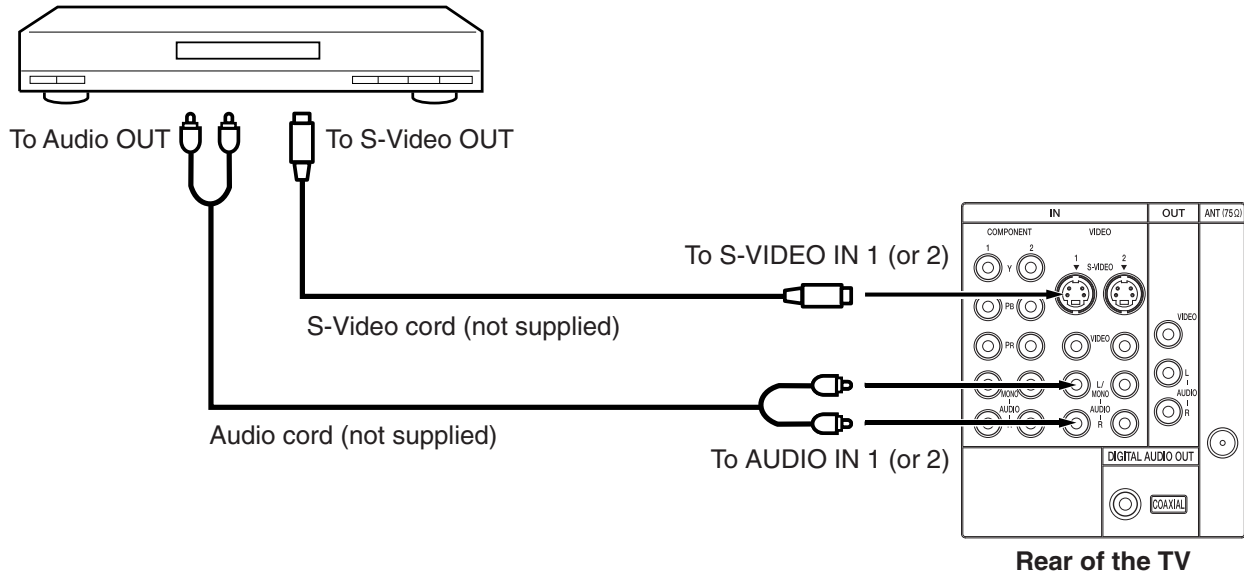

To connect the TV to a DVD player with component video

If your DVD player has component video out jacks, connect your TV to a DVD player using a component video cord. It can greatly enhance picture quality and performance.

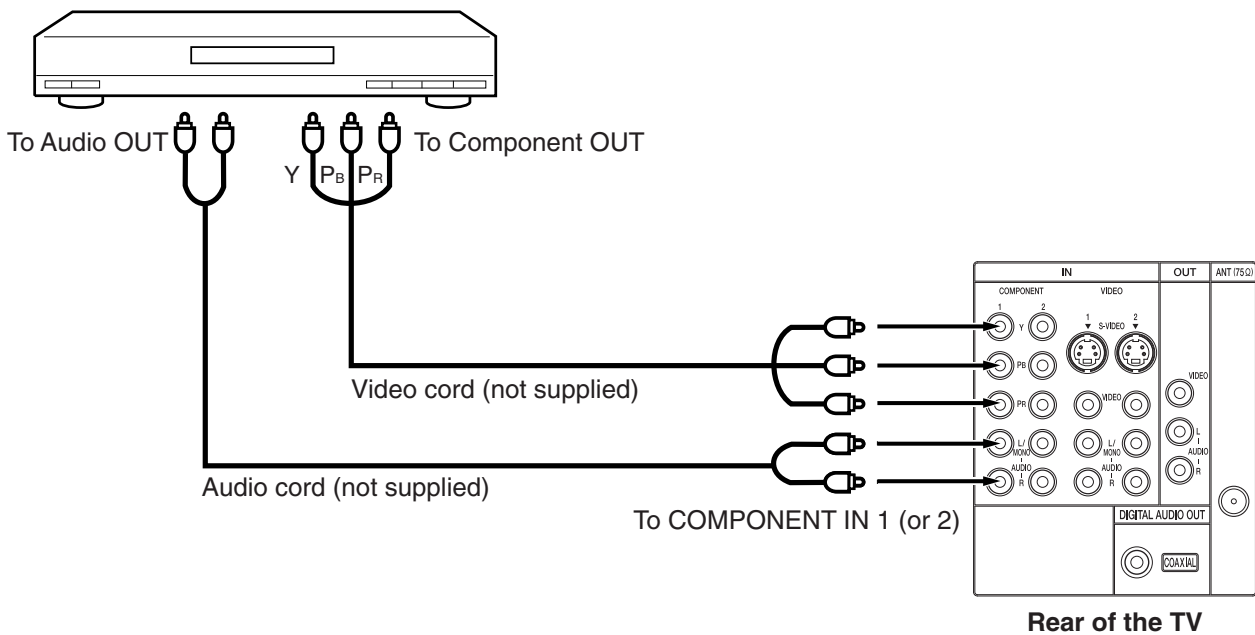

NOTE:

Component Video input of this unit are for use of device which output 480i/1080i interlaced signals and 480p/720p progressive signals.

Connections to other equipment

(continued)

To connect the TV to a DTV receiver/set-top box

If you connect a DTV receiver/set-top box, connect your TV to a DTV receiver/set-top box using a component video cord.

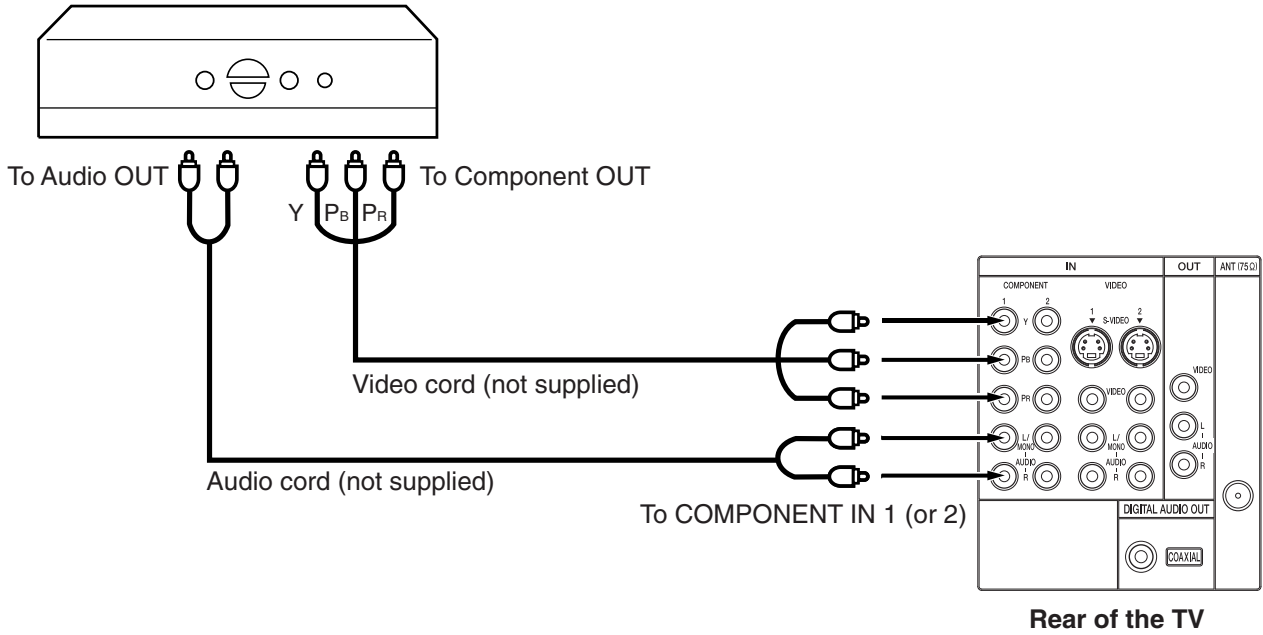

Connections to other equipment

(continued)

Using an Audio Amplifier

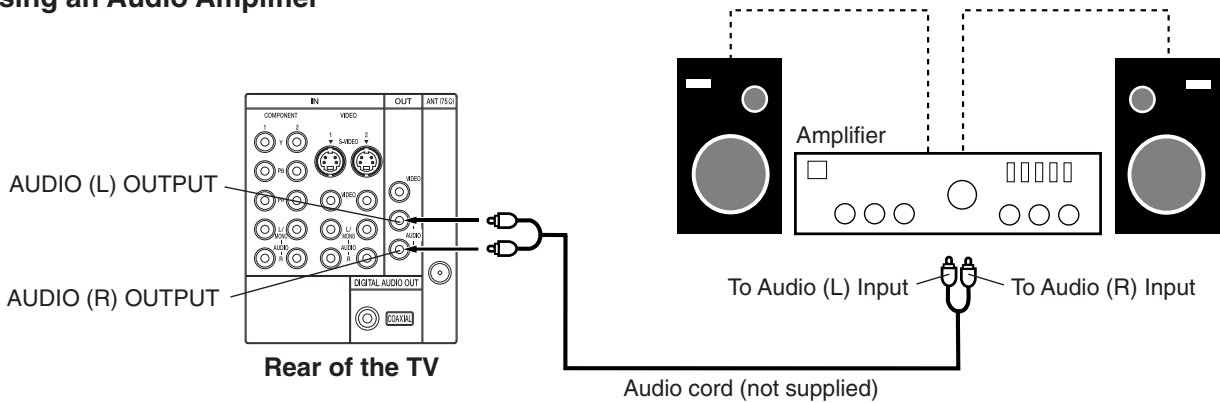

Using an AV Amplifier with built-in digital surround

If you are using an Amplifier with built-in digital surround sound as follows, you can enjoy various audio systems including Dolby Digital Surround audio that sounds just like the movie.

Connect an AV amplifier with built-in Dolby Digital decoder, or etc as shown below.

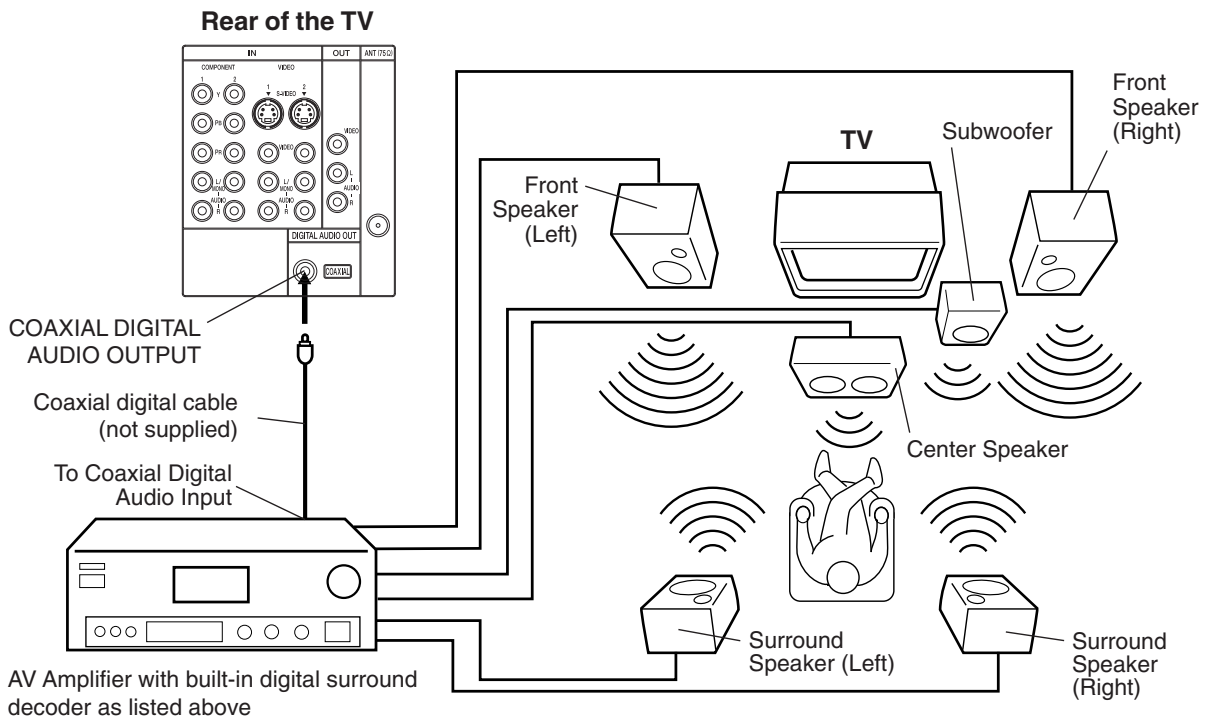

* Manufactured under license from Dolby Laboratories. "Dolby" and the double-D symbol are trademarks of Dolby Laboratories.

NOTE:

When you make the connection above, on the AV Amplifier, do not set DOLBY DIGITAL to DOLBY DIGITAL, or MPEG to MPEG "ON". If you do, a loud noise will emit from the speakers possibly causing damage to your hearing or to the speakers.

To connect the TV to a camcorder

To playback from a camcorder, connect the camcorder to the TV as shown.

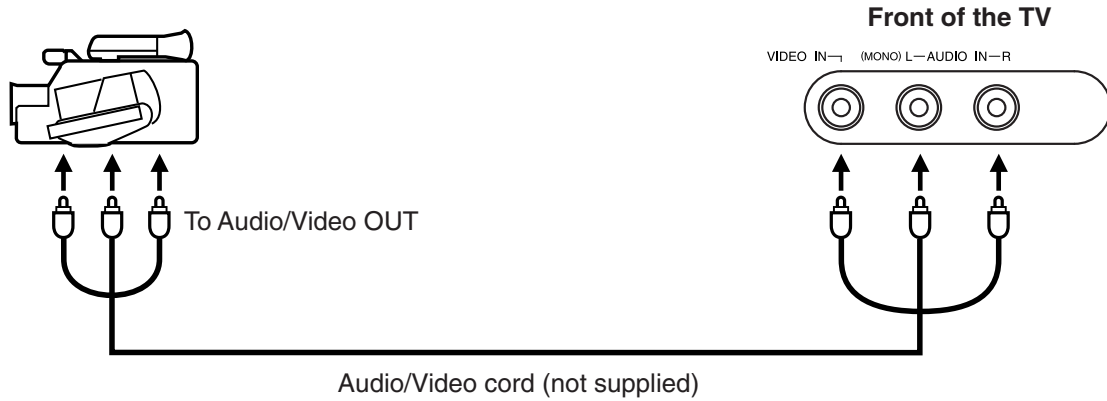

To connect the TV to a Game

The TV can also be used as a display device for many video games. However, due to the wide variety of signals generated by these devices and subsequent hook-up variations required, they have not all been included in the suggested connection diagrams. You'll need to consult each component's Owner's Manual for additional information.

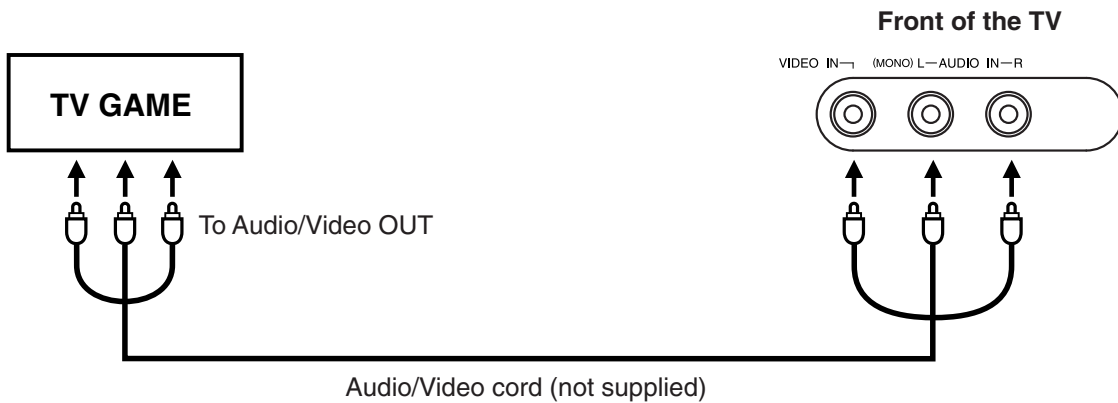

Starting setup

The **STARTING SETUP** menu appears the first time you turn on the TV, and helps you select the menu language, specify the TV/CABLE setting, and program channels automatically.

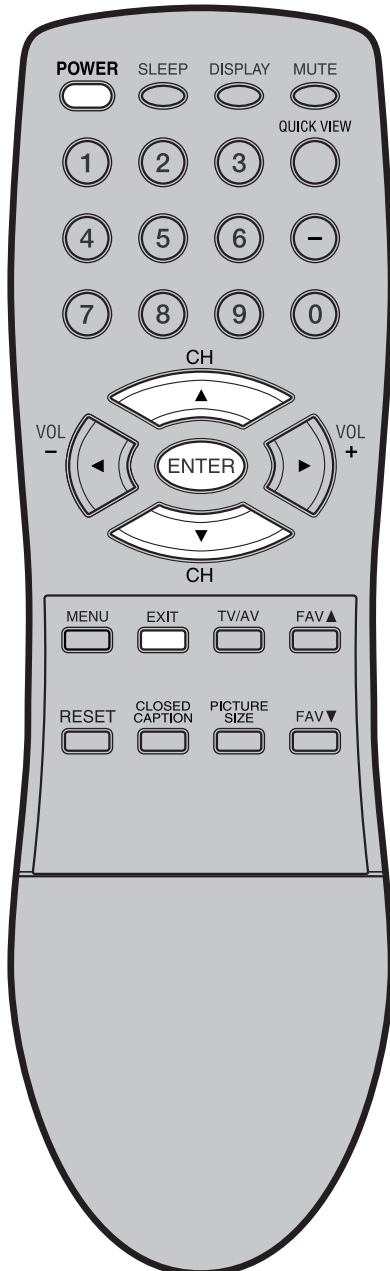

IMPORTANT: Make sure that the antenna or cable TV system connection is made!

1 Press **POWER**. The starting setup function begins and the Language setup menu appears on the screen. Press **▲** or **▼** to select your desired language, then press **ENTER**.

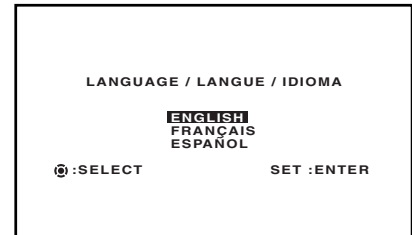

2 Press **▲** or **▼** to select "TV" or "CABLE", then press **ENTER**.

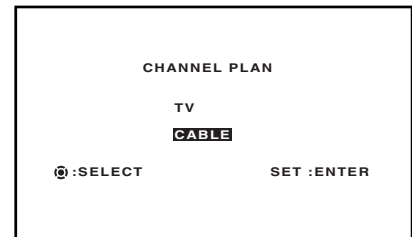

3 Press **▲** or **▼** to select "START", then press **ENTER**. If you select "CANCEL" and press **ENTER**, the **STARTING SETUP** stops and changes to the TV screen.

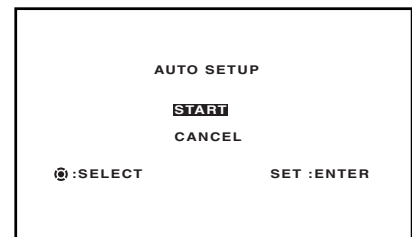

4 Now the "AUTO SETUP" starts. After the starting setup is completed, the TV channel appears on the screen.

- It may take up to 30 minutes to complete memorizing digital cable channels, please be patient.

NOTE:

If you press **EXIT** in the process of "AUTO SETUP", the **STARTING SETUP** stops and changes to the normal screen.

- When you make a menu selection, your changes occur immediately. You do not have to press **EXIT** to see your changes.
- When you are finished programming the menus, press **EXIT**.

Setting the language

You can choose from three different languages (English, French and Spanish) for the on-screen displays.

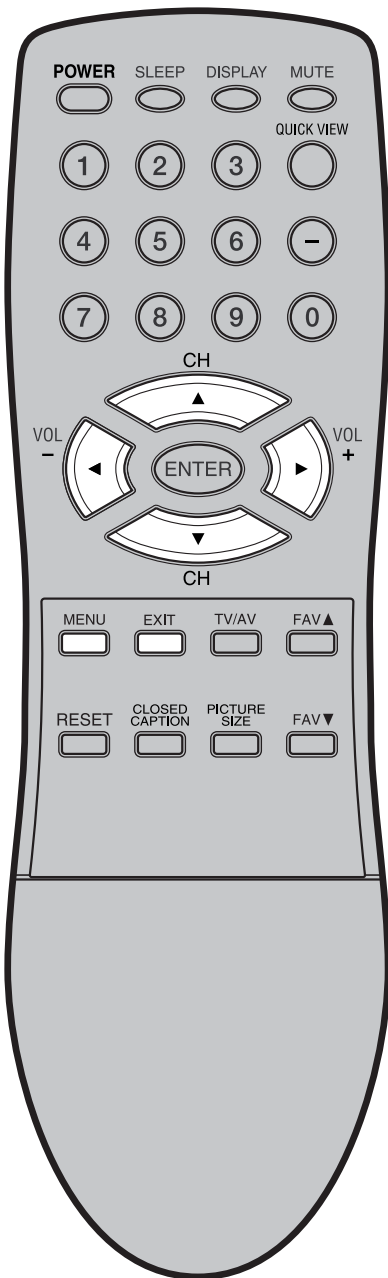

1 Press **MENU**. The menu screen will appear.

2 Then press ◀ or ▶ to select **SETUP** menu.

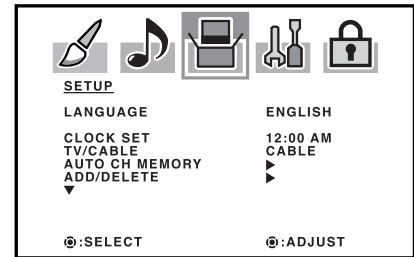

3 Press ▲ or ▼ to select "LANGUAGE".

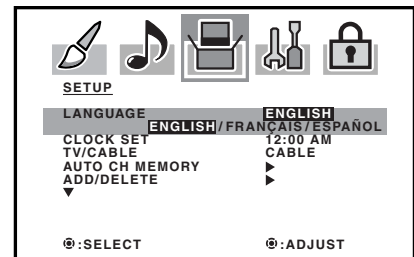

4 Press ◀ or ▶ to select the desired language: English (ENGLISH), French (FRANÇAIS) or Spanish (ESPAÑOL).

5 Press **EXIT** to return to the normal screen.

NOTE:

If no buttons are pressed for more than 15 seconds, the MENU screen will return to normal TV-operation automatically.

Memorizing channels

This TV is equipped with a channel memory feature which allows channels to skip up or down to the next channel set into memory, skipping over unwanted channels. Before selecting channels, they must be programmed into the TV's memory. This TV can receive up to 250 VHF/UHF channels and 500 cable TV channels. To use this TV with an antenna, set the TV/CABLE menu option to the TV mode. When shipped from the factory, this menu option is in the CABLE mode.

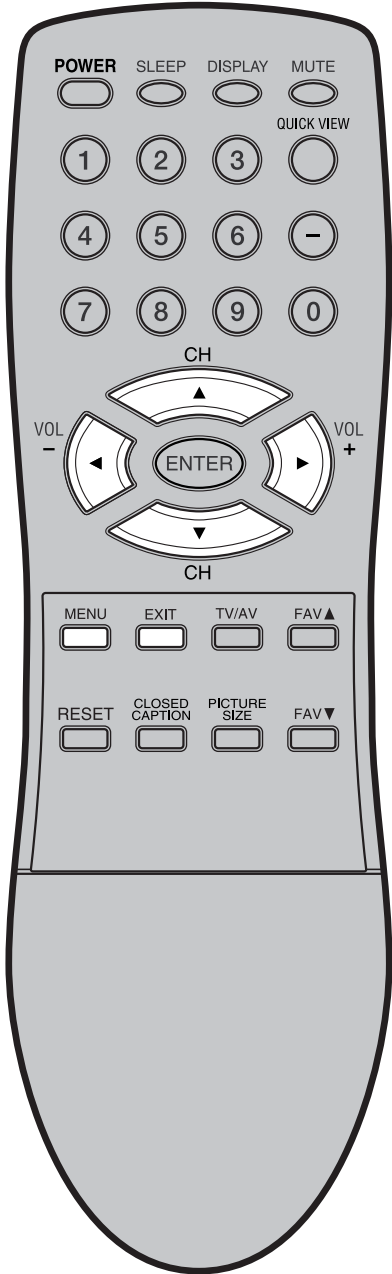

TV/CABLE selection

1 Press **MENU**. The menu screen will appear.

2 Press **◀** or **▶** to select **SETUP** menu.

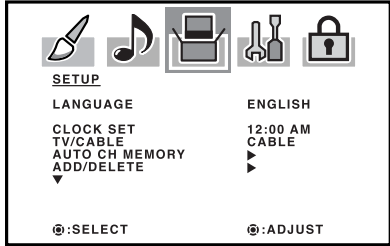

3 Press **▲** or **▼** to select **"TV/CABLE"**.

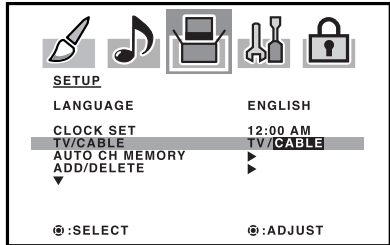

4 Press **◀** or **▶** to select **"TV"** or **"CABLE"**.

TV - VHF/UHF channels
CABLE - CABLE TV channels

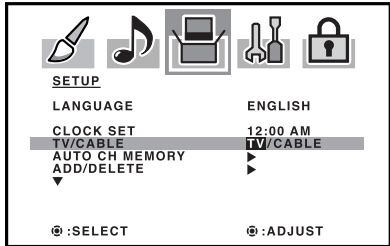

5 Press **EXIT** to return to the normal screen.

CABLE CHART

The chart below is typical of many cable system channel allocations.

Number on this TV														14	15	16	17	18	19	20	21	22													
Corresponding CABLE channel														A	B	C	D	E	F	G	H	I													
23	24	25	26	27	28	29	30	31	32	33	34	35	36	37	38	39	40	41	42	43	44	45	46	47	48	49	50	51	52	53	54	55	56	57	58
J	K	L	M	N	O	P	Q	R	S	T	U	V	W	AA	BB	CC	DD	EE	FF	GG	HH	II	JJ	KK	LL	MM	NN	OO	PP	QQ	RR	SS	TT	UU	VV
59	60	61	62	63	64	65	66	67	68	69	70	71	72	73	74	75	76	77	78	79	80	81	82	83	84	85	86	87	88	89	90	91	92	93	94
RRR	SSS	TTT	UUU	VVV	WWW	XXX	YYY	ZZZ	86	87	88	89	90	91	92	93	94	95	96	97	98	99	100	101	102	103	104	105	106	107	108	109	110	111	112
A-5	A-4	A-3	A-2	A-1	100	101	102	103	104	105	106	107	108	109	110	111	112	113	114	115	116	117	118	119	120	121	122	123	124	125	01				
113	114	115	116	117	118	119	120	121	122	123	124	125	01																						
113	114	115	116	117	118	119	120	121	122	123	124	125	5A																						

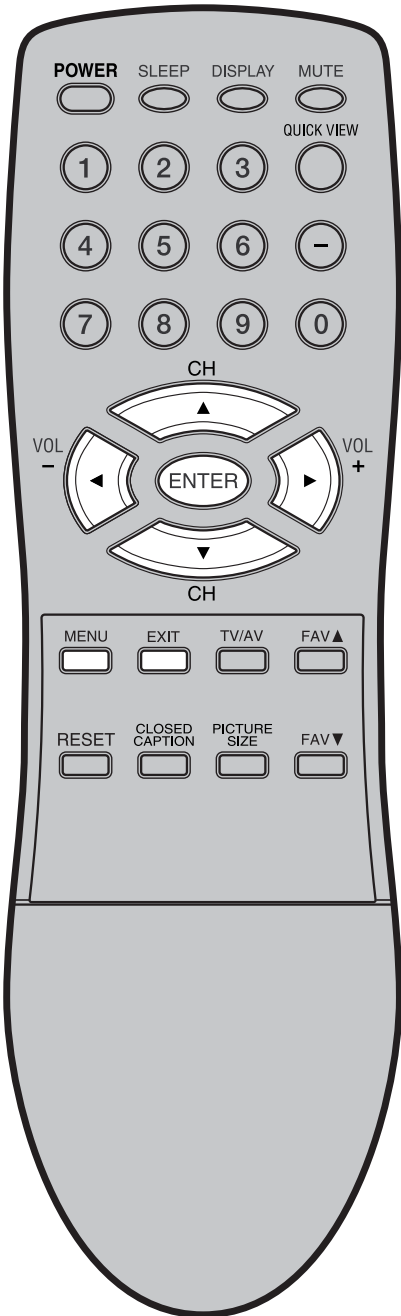

Automatic memory tuning

- 1 Press **MENU**. The menu screen will appear.
- 2 Press ◀ or ▶ to select **SETUP** menu, then press ▲ or ▼ to select **"AUTO CH MEMORY"**.

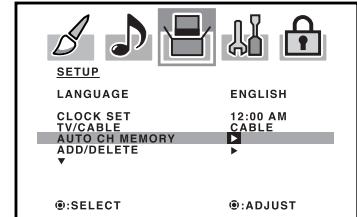

- 3 Press ◀ or ▶. The TV will begin memorizing all the channels available in your area.

- It may take up to 30 minutes to complete memorizing digital cable channels, please be patient.

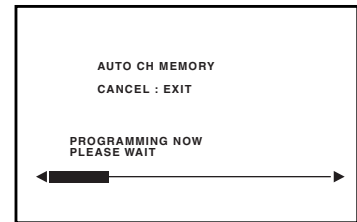

- 4 Press **EXIT** to return to the normal screen.

To add/delete channels

- 1 Press **MENU**. The menu screen will appear.
- 2 Press ◀ or ▶ to select **SETUP** menu, then press ▲ or ▼ to select **"ADD/DELETE"**. Press ◀ or ▶. The **ADD/DELETE** menu will appear.

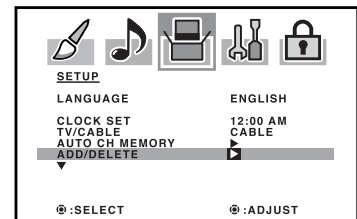

- 3 Press ▲ or ▼ to select **"ADD/DELETE"**, then press ▶.

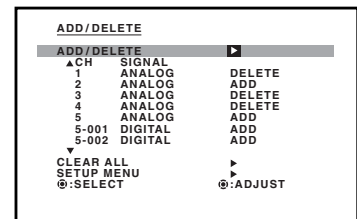

- 4 Select the desired channel to be memorized or deleted using ▲ or ▼. Press ◀ or ▶ to select **"ADD"** or **"DELETE"**, whichever function you want to perform.

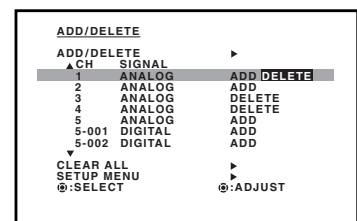

- 5 Repeat step 4 for other channels you want to add or delete, then press **ENTER**.

- 6 Press **EXIT** to return to the normal screen.

CLEAR ALL

All channels are deleted from the channel memory.

Press ▲ or ▼ to select **"CLEAR ALL"** in step 2 above, then press ◀ or ▶.

NOTE:
Some new channels may be appeared. So, it is recommended to do the "AUTO CH MEMORY" procedure periodically.

Setting your favorite channels

You can preset up to 12 of your favorite channels.

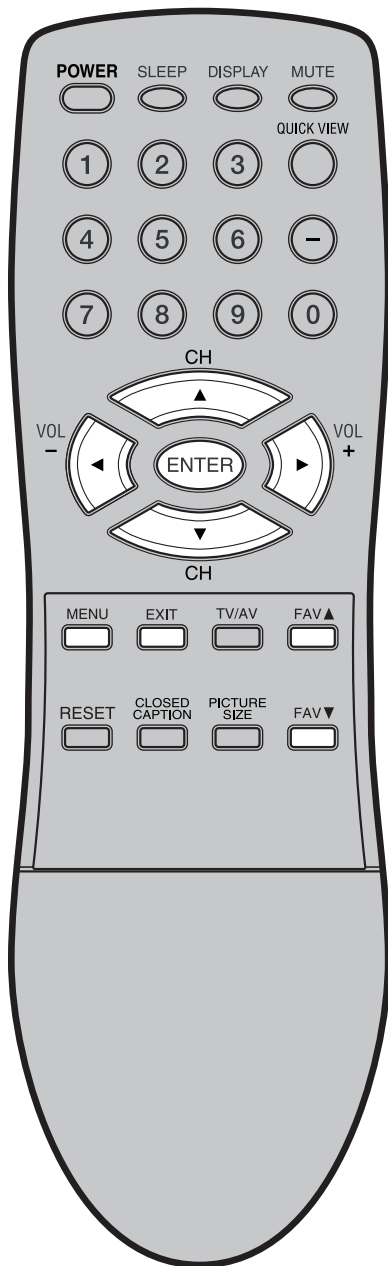

NOTES:

- You can still use **CH ▲** or **▼** to scan through all the channels you programmed in the TV's memory.
- **FAV ▲** or **▼** will not work until you have programmed your favorite channels.

Setting your favorite channels

1 Select a channel you wish to include in your favorite channel list.

2 Press **MENU**, then press **◀** or **▶** to select **OPTION** menu.

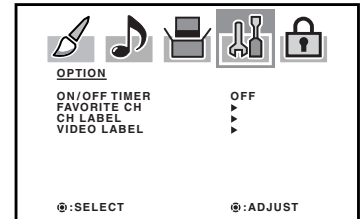

3 Press **▲** or **▼** to select "FAVORITE CH", then press **◀** or **▶**. The **FAVORITE CH** menu will appear.

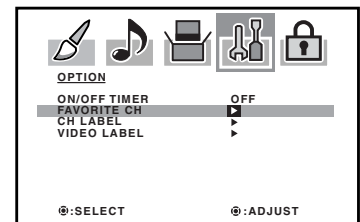

4 Press **◀** or **▶** to select "SET" and press **ENTER**.

5 Press **EXIT** to return to the normal TV screen.

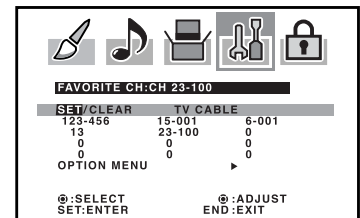

6 Repeat steps 1-5 for up to 11 additional channels.

To watch your favorite channels

Press **FAV ▲** or **▼** on the remote control to select your favorite channels.

To delete your favorite channels

1 Select a channel you want to remove from favorite channels.

2 Press **MENU**, then press **◀** or **▶** to select **OPTION** menu. Press **▲** or **▼** to select "FAVORITE CH", then press **◀** or **▶** to display the **FAVORITE CH** menu.

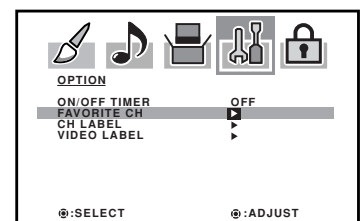

3 Press **◀** or **▶** to select "CLEAR" and press **ENTER**.

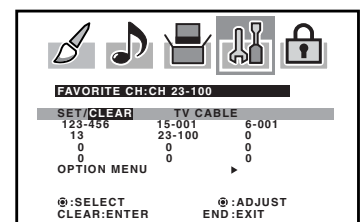

4 Press **EXIT** to return to the normal screen.

TV operation

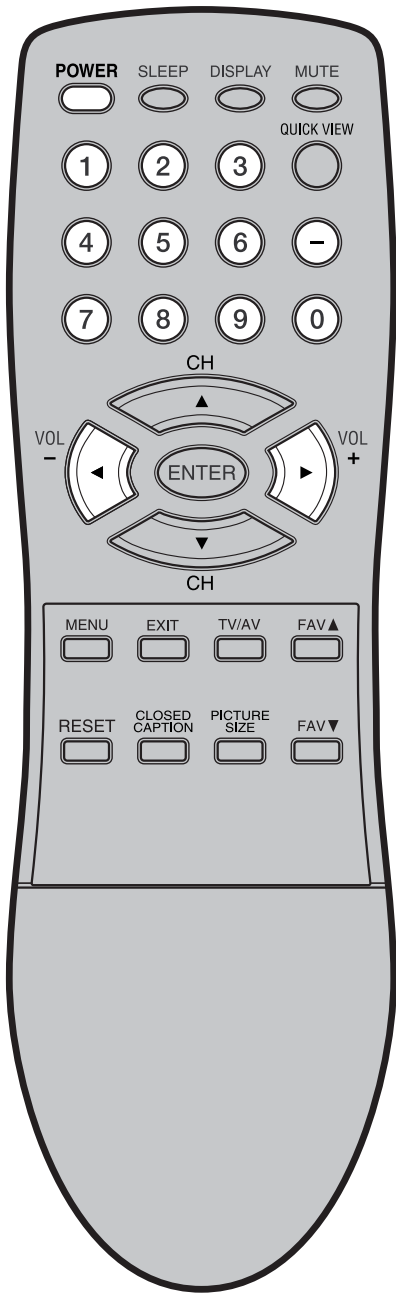

NOTES:

- If a channel with no broadcast is selected, the sound will automatically be muted.
- If a station being viewed stops broadcasting, the TV will automatically shut itself off after 15 minutes.

1 To turn on the TV, press **POWER**.

2 Adjust the volume level by pressing **VOL +** or **-**. The volume level will be indicated on the screen by green bars. As the volume level increases, so do the number of bars. If the volume decreases, the number of green bars also decreases.

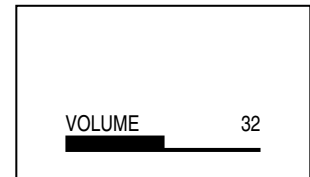

3 Set the TV/CABLE menu option to the appropriate position (see page 17).

TV - VHF/UHF channels
CABLE - CABLE TV channels

4 Press the **Direct Channel Selection** buttons to select the channel.

TO SELECT ANALOG CHANNELS

1-9: Press **0** twice, then 1-9 as needed. Example, to select channel 2, press **0 0 2**.

10-99: Press **0**, then the remaining 2 digits. Example, to select channel 12, press **0 1 2**.

100-125: Press the 3 digits in order. Example, to select channel 120, press **1 2 0**.



TO SELECT DIGITAL CHANNELS

Press the first 3 digits, then press **"-"**, followed by the remaining 3 digits.

Example, to select channel 015-001, press **0 1 5 - 0 0 1**.

VHF/UHF/CABLE CHANNELS

TV	CABLE
VHF 2-13	VHF 2-13
UHF 14-69	STD/HRC/IRC 14-36 (A) (W) 37-59 (AA) (WW) 60-85 (AAA) (ZZZ) 86-94 (86) (94) 95-99 (A-5) (A-1) 100-125 (100) (125) 01 (5A)

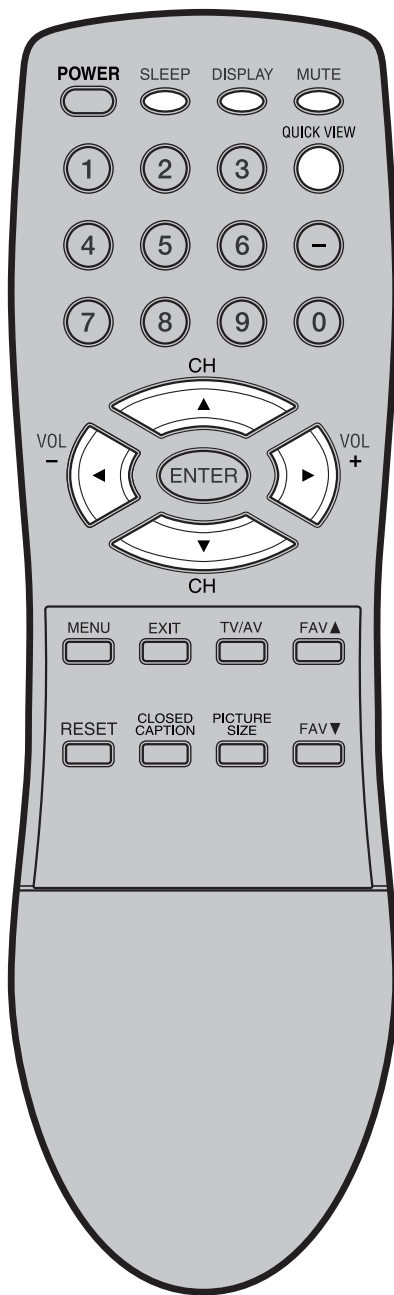

NOTE:
When TV receives an analog signal, **DISPLAY** shows only analog information.

CH ▲/▼

Press and release **CH ▲** or **▼**. The channel automatically stops at the next channel set into memory. For proper operation, before selecting channels, they should be set into the memory. See pages 17 and 18 "Memorizing channels".



DISPLAY

Press **DISPLAY** to display the current information on the screen.

When TV receives digital signal, press once, the digital information will appear.

- Broadcast program name
- Station name
- Audio language
- V-CHIP RATING
- Closed Caption mark
- Remaining time
- Program name
- HD or SD mark
- V-Chip mark

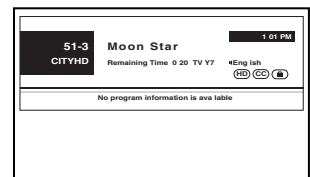

Press **DISPLAY** again, the analog information will appear.

- Clock
- Channel number or VIDEO mode selected
- Channel label (if preset)
- Stereo or SAP (second audio program) audio status
- Content rating
- On timer, Off timer, Sleep time (if preset)
- Picture size



Press **DISPLAY** again to clear the call display.

QUICK VIEW

This button allows you to go back to the last channel selected by pressing **QUICK VIEW**. Press **QUICK VIEW** again to return to the last channel you were watching.



MUTE

Press **MUTE** to switch off the sound. The unit's sound will be silenced and "MUTE" will appear on the screen. The sound can be switched back on by pressing this button again or the **VOL +** or **-**.

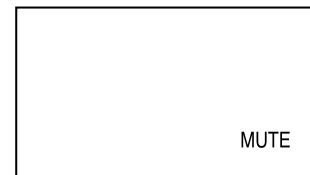

SLEEP

To set the unit to turn off after a preset amount of time, press **SLEEP** on the remote control. The clock will count up 10 minutes for each press of the **SLEEP** button (0h00m, 0h10m, ...1h50m, 2h00m). After the sleep time is programmed, the display will appear briefly every ten minutes to remind you that the sleep timer is operating. To confirm the sleep timer setting, press **SLEEP** and the remaining time will be displayed for a few seconds. To cancel the sleep timer, press **SLEEP** repeatedly until the display turns to 0h00m.

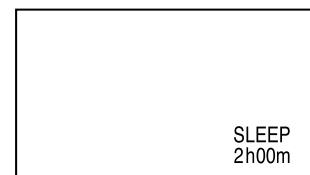

Setting the V-Chip

An age limitation can be set to restrict children from viewing or hearing violent scenes or picture that you may choose to exclude. The restriction applies to "TV RATING" and "MOVIE RATING" if this data is transmitted. You may set this restriction separately. To use the V-Chip function, you must register a password.

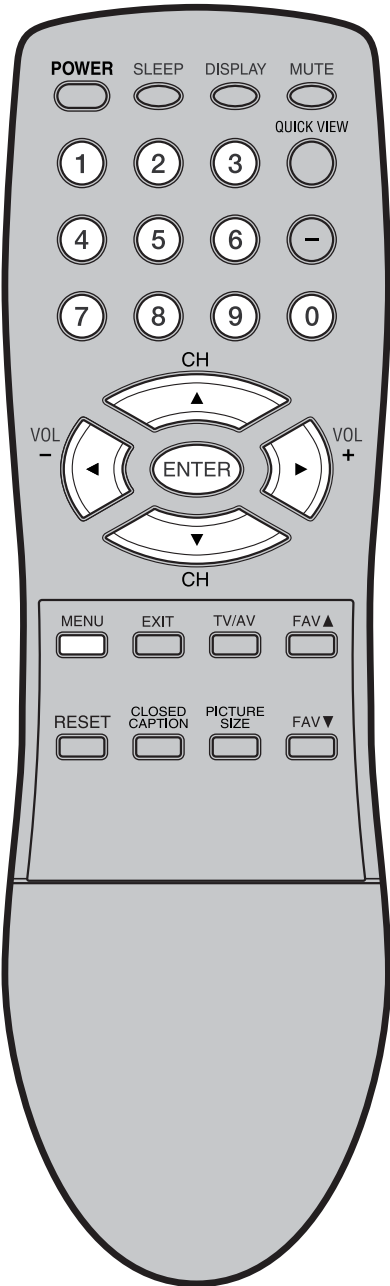

To register a password

1 Press **MENU**. The menu screen will appear. Then press ◀ or ▶ to select **LOCKS** menu.

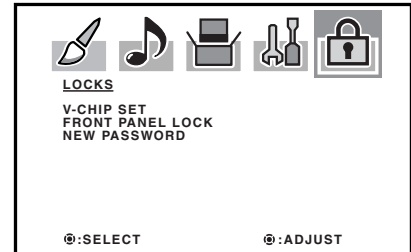

2 Press ▲ or ▼ to display the password entering mode.

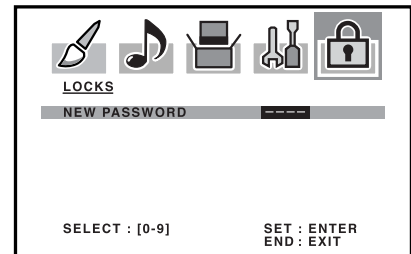

3 Enter the password (4 digits) using **number buttons (0-9)**, then press **ENTER**.

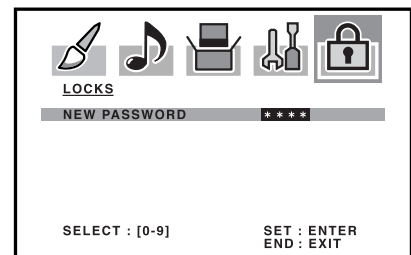

"*" appears instead of the number.

4 Enter the same password again for the safety, then press **ENTER**. The password is now registered and the V-Chip menu will appear on the screen.

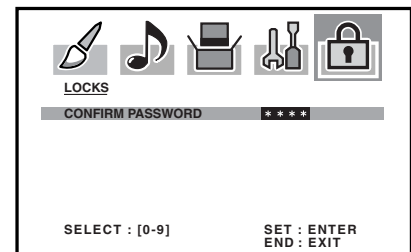

NOTES:

- If you forget the password, contact Customer Service at 1-800-289-0980 for assistance. Your original remote control will be required.
- To avoid forgetting the password, write it down and keep it in a safe place.

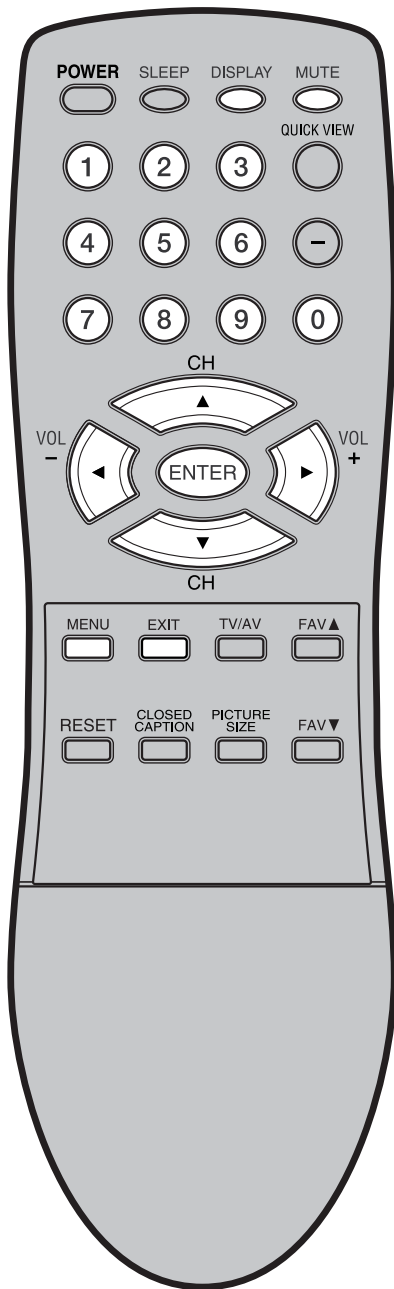

To use the TV after the TV is protected.

When the program applied to the V-Chip setting is received, press **MUTE** and enter the password, then press **ENTER**. When the password is entered correctly the protection will be temporarily overridden.

NOTE:

The V-Chip function is activated only on programs and input sources that have the rating signal.

To set the V-CHIP

1 Press **MENU**, then press ◀ or ▶ to select **LOCKS** menu.

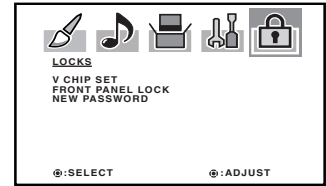

2 Press ▲ or ▼ to display the password entering mode. Use **number buttons (0-9)** to enter your password, then press **ENTER**. The **LOCKS** menu appears.

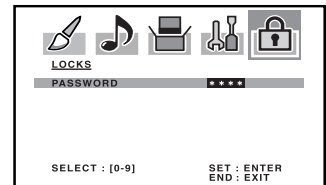

3 Press ▲ or ▼ to select "TV RATING". Then press ◀ or ▶ to display the desired rating.

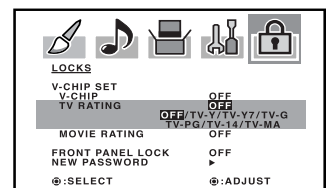

- OFF** : TV RATING is not set
- TV-Y** : All children
- TV-Y7** : 7 years old and above
- TV-G** : General audience
- TV-PG** : Parental guidance
- TV-14** : 14 years old and above
- TV-MA** : 17 years old and above

- When you select TV-Y7, TV-PG, TV-14 or TV-MA, press **DISPLAY** to explain the rating. Press ▲ or ▼ to select the desired rating you want. Press ◀ or ▶ to select the setting "ON" or "OFF".

4 Press ▲ or ▼ to select "MOVIE RATING". Then press ◀ or ▶ to display the desired rating.

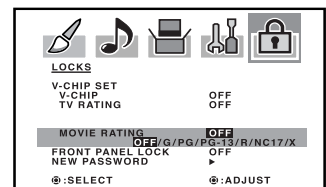

- OFF** : MOVIE RATING is not set
- G** : All ages
- PG** : Parental guidance
- PG-13** : Parental guidance less than 13 years old
- R** : Under 17 years old Parental guidance suggested
- NC17** : 17 years old and above
- X** : Adult only

5 Press ▲ or ▼ to select "V-CHIP".

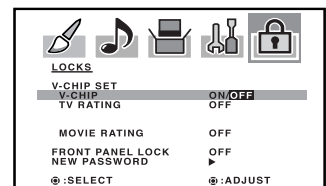

6 Press ◀ or ▶ to select "ON". Your settings are now set into memory.

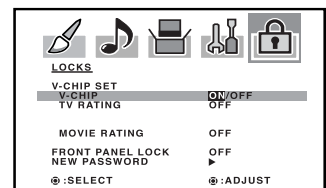

7 Press **EXIT** to return to the normal screen.

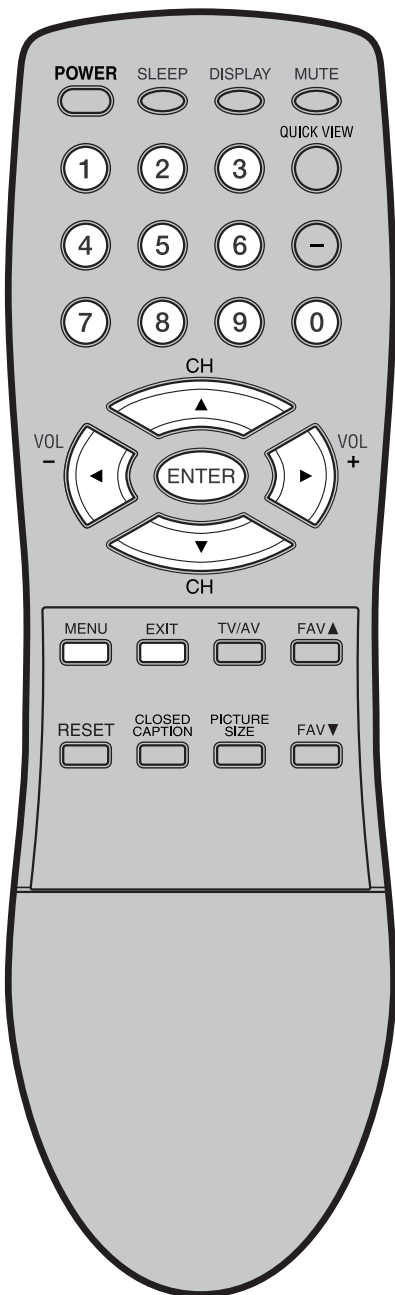

To change the password

- 1 Press **MENU**, then press ◀ or ▶ to select **LOCKS** menu.
- 2 Press ▲ or ▼ to display the password entering mode. Use the **number buttons (0-9)** to enter your password, then press **ENTER**. The **LOCKS** menu appears.
- 3 Press ▲ or ▼ to select "NEW PASSWORD", then press ◀ or ▶.
- 4 Enter a new password using the **number buttons (0-9)**, then press **ENTER**.
- 5 Enter the same password again to confirm, then press **ENTER**.
- 6 Press **EXIT** to return to the normal screen.

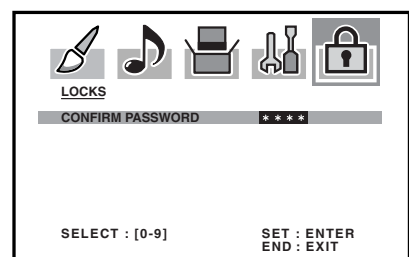
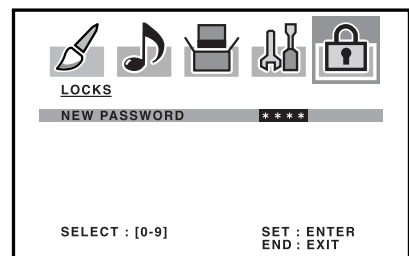
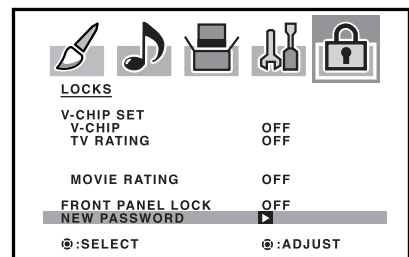
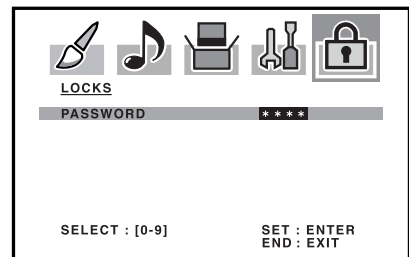
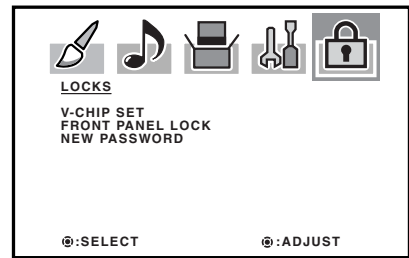

Setting the front panel lock

You can lock the front panel buttons to prevent your settings from being changed accidentally (by children, for example). When the front panel lock is in ON, all control buttons on the TV front panel (except POWER) do not operate.

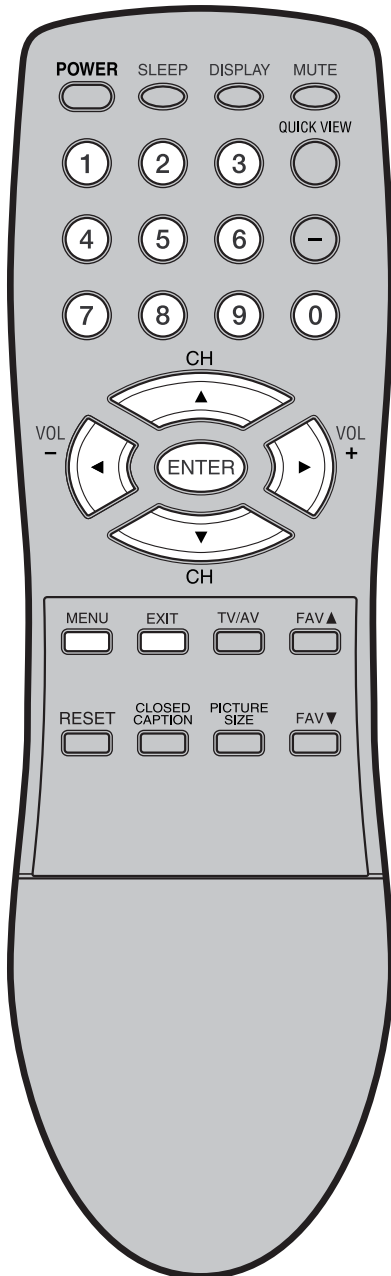

To lock the front panel

1 Press **MENU**, then press ◀ or ▶ to select LOCKS menu.

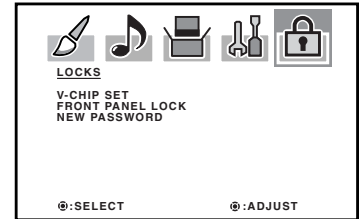

2 Press ▲ or ▼ to display the password entering mode. Use the **number buttons (0-9)** to enter your password, then press **ENTER**. The LOCKS menu appears.

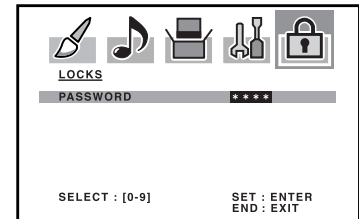

3 Press ▲ or ▼ to select "FRONT PANEL LOCK" and press ◀ or ▶ to select "ON".
If a button on the front panel is pressed, the message "NOT AVAILABLE" appears.

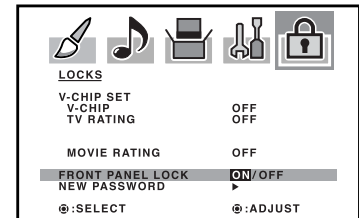

4 Press **EXIT** to return to the normal screen.

To unlock the front panel

Press and hold **VOLUME ▼** on the front panel of TV for about 10 seconds until the message "FRONT PANEL LOCK:OFF" appears on the screen.

You also can unlock the front panel using the menu

1 Press **MENU**, then press ◀ or ▶ to select LOCKS menu.

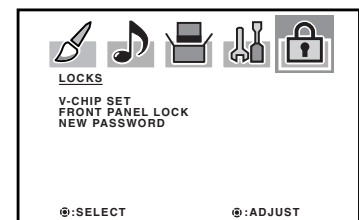

2 Press ▲ or ▼ to display the password entering mode. Use the **number buttons (0-9)** to enter your password, then press **ENTER**. The LOCKS menu appears.

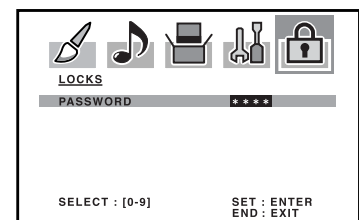

3 Press ▲ or ▼ to select "FRONT PANEL LOCK", then press ◀ or ▶ to select "OFF".

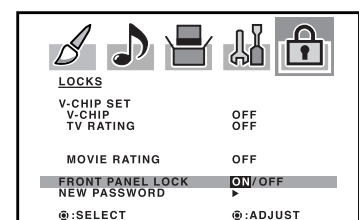

4 Press **EXIT** to return to the normal screen.

Labeling channels

Channel labels appear over the channel number display each time you turn on the TV, select a channel, or press DISPLAY. You can choose any four characters to identify a channel.

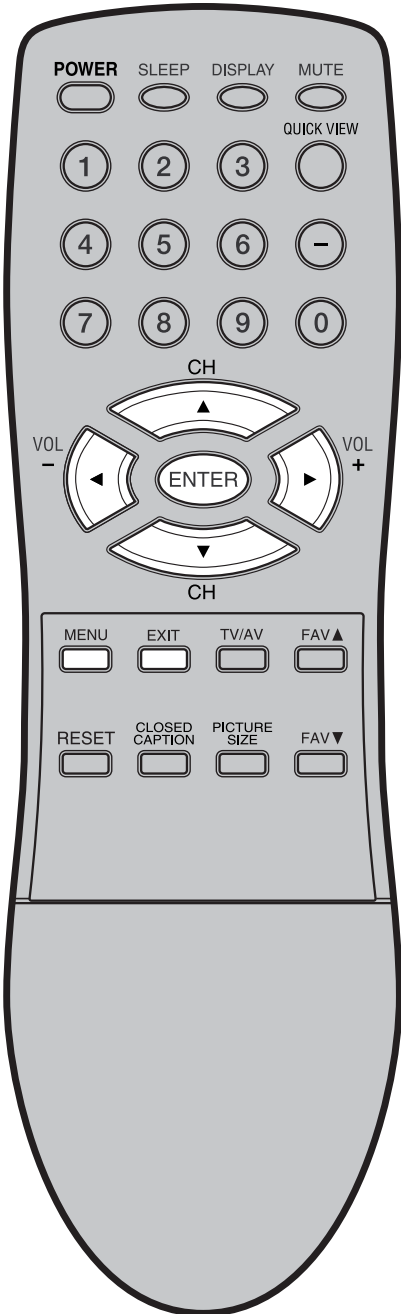

To create channel labels

- 1 Select a channel you want to label.
- 2 Press **MENU**, then press ◀ or ▶ to select OPTION menu. Press ▲ or ▼ to select "CH LABEL", then press ◀ or ▶. The CH LABEL menu will appear.
- 3 Press ▲ or ▼ to select "SET/CLEAR". Press ◀ or ▶ to select "SET".
- 4 Press **ENTER** to select "LABEL". Then press ◀ or ▶ to enter a character in the first space. Press the button repeatedly until the character you want appears on the screen.

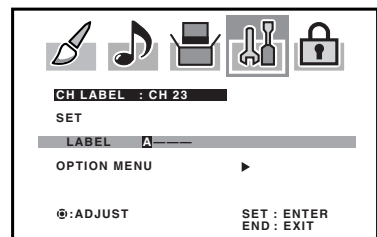
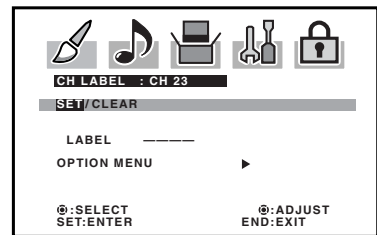
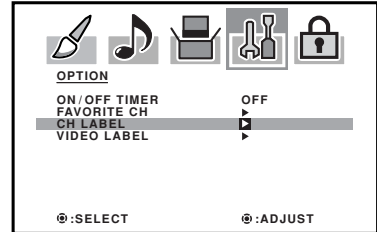

The characters rotation as follows:

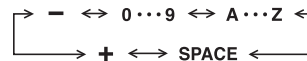

If the character which you desire appears, press **ENTER**. Repeat this step to enter the rest of the characters. If you would like a blank space in the label name, you must choose the empty space from the list of characters; otherwise, a dash will appear in that space. When you finish inputting label name, press **ENTER**.

- 5 Press **EXIT** to return to the normal screen.
- 6 Repeat steps 1-5 for other channels. You can assign a label to each channel.

To erase channel labels

- 1 Select a channel with a label which you want to remove.
- 2 Press **MENU**, then press ◀ or ▶ to select OPTION menu. Press ▲ or ▼ to select "CH LABEL", then press ◀ or ▶ to display the CH LABEL menu.
- 3 Press ▲ or ▼ to select "SET/CLEAR". Press ◀ or ▶ to select "CLEAR", then press **ENTER**.
- 4 Press **EXIT** to return to the normal screen.
- 5 Repeat steps 1-3 to erase other channel labels.

Labeling the video input source

The video label feature allows you to label each input source for your TV.

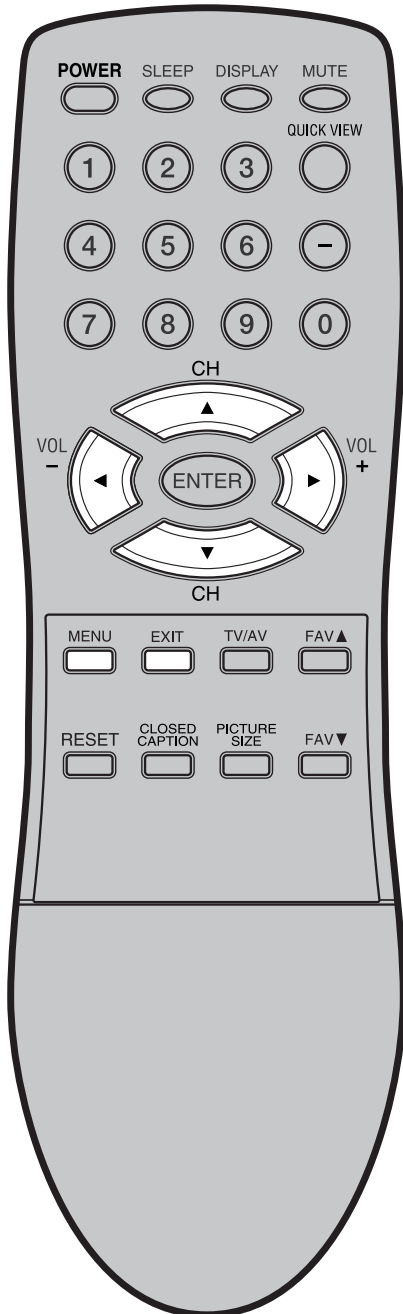

- 1 Press **MENU**, then press ◀ or ▶ to select **OPTION** menu. Press ▲ or ▼ to select "VIDEO LABEL".

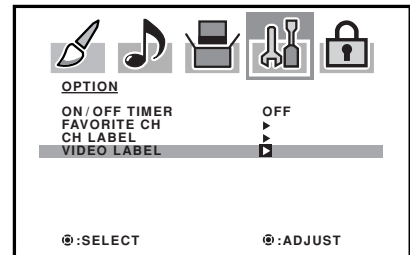

- 2 Press ◀ or ▶. The **VIDEO LABEL** menu will appear.

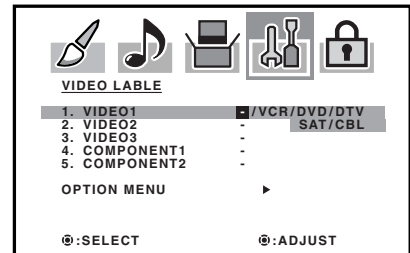

- 3 Press ▲ or ▼ to select the video source you want to label.

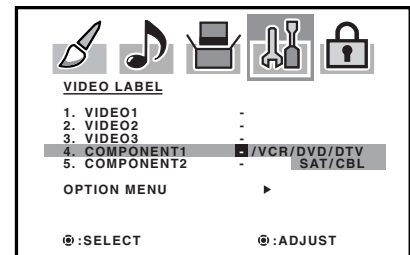

- 4 Press ◀ or ▶ to select the desired label for that input source.

- : Uses the default label name

VCR : Video cassette recorder

DVD : DVD video

DTV : Digital TV set-top box

SAT : Satellite box

CBL : Cable box

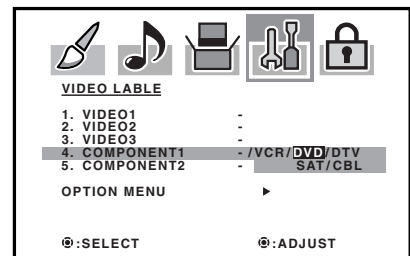

- 5 Press **EXIT** to return to the normal screen.

Setting the clock

You must set the clock correctly for the "ON/OFF TIMER" to activate at the correct time.

EXAMPLE: Setting the clock to "8:30 AM".

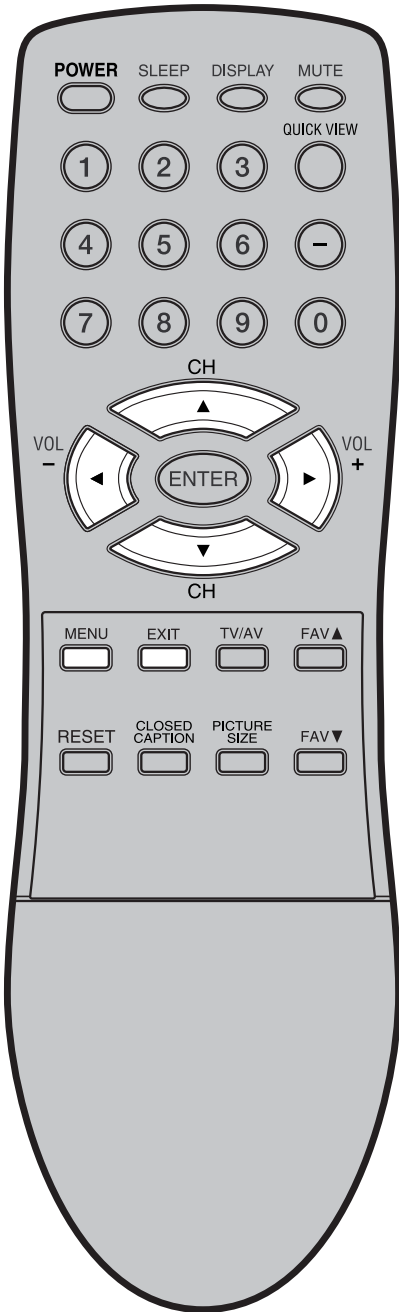

1 Press **MENU**, then press ◀ or ▶ to select **SETUP** menu.

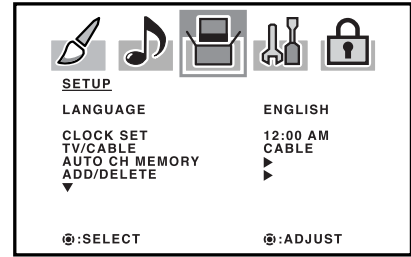

2 Press ▲ or ▼ to select "CLOCK SET". Then press ◀ or ▶ to select the hour position.

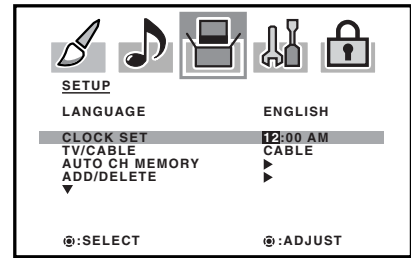

3 Press ▲ or ▼ to set the hour. Please note if the hour is AM or PM, and choose desired setting. Then press ▶ to select the minute position.

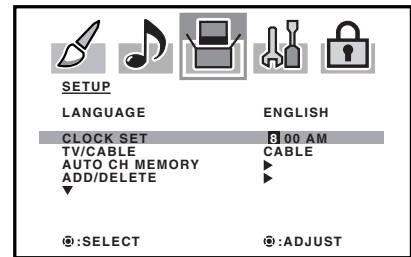

4 Press ▲ or ▼ to set the minutes.

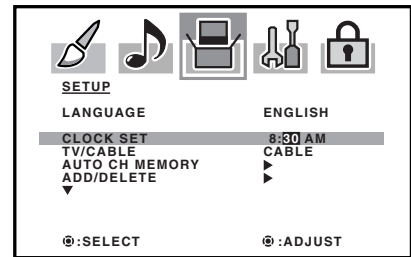

5 Press **EXIT** to return to the normal screen.

NOTE:

After a power failure or disconnection of the power, the clock settings will be lost. In this case, reset the present time.

Setting the on timer

This feature allows you to have the TV automatically turn on at a predetermined time. If you program the ON TIMER to daily once, the TV will turn on everyday at the same time to the same channel.

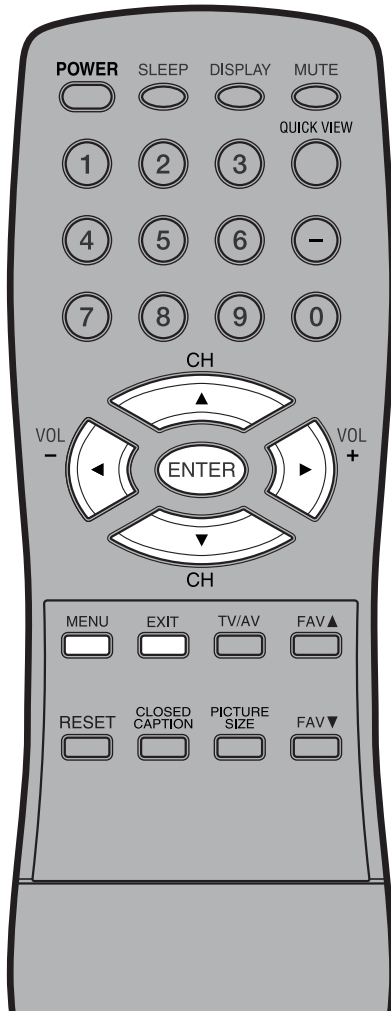

NOTES:

- The TV will automatically turn off approximately 1 hour later after the ON TIMER turns on if no OFF TIMER has been set. To continue watching the TV, press any button to cancel the one hour automatic shut off.
- If a station being viewed stops broadcasting, the TV will automatically shut itself off after 15 minutes.
- To cancel ON TIMER, Select "CLEAR" in step 6. Press **EXIT** to return to normal screen.
- After a power failure or disconnection of the power, the timer settings will be lost.
- To return from ON/OFF TIMER menu to OPTION menu, select "OPTION MENU" then press ◀ or ▶.

EXAMPLE: Turning on the TV to channel 12 at 7:30 AM, daily.

Preparation:

Set the clock, if you have not already done so (see page 28).

1 Press **MENU**. Press ◀ or ▶ to select OPTION menu. Press ▲ or ▼ to select "ON/OFF TIMER".

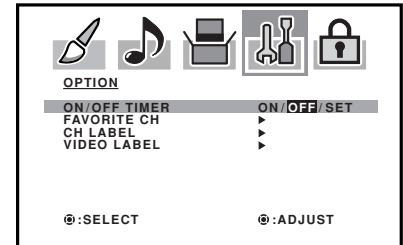

2 Press ◀ or ▶ to select "SET", then press **ENTER**. The ON/OFF TIMER menu appears.

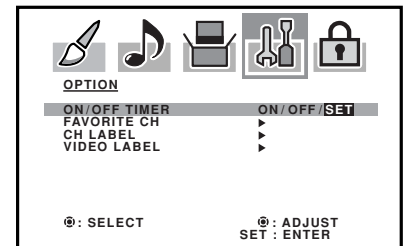

3 Press ▲ or ▼ to select "ON TIMER", then press ▶ to enter to setting of ON TIMER.

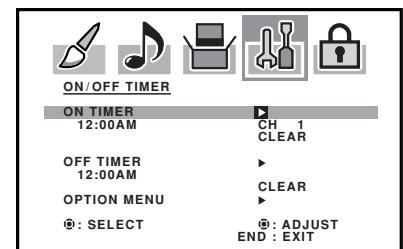

4 Press ▲ or ▼ to set the desired hour, then press ▶. Please note if the hour is AM or PM, and choose desired setting.

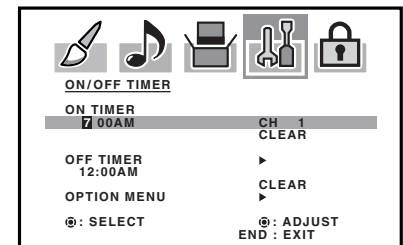

5 Set the desired minutes and start up channel, as in step 4.

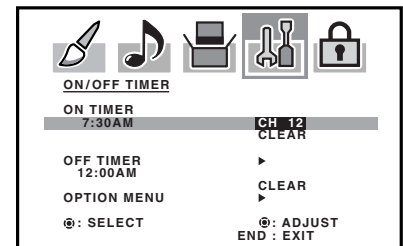

6 Press ◀ or ▶ to select "DAILY", then press **ENTER**.

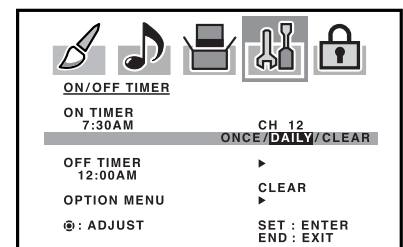

7 Press **EXIT** to return to the normal screen.

Setting the off timer

This feature allows you to have the TV turn off automatically at a predetermined time. If you program the OFF TIMER once, the TV will automatically turn off at the same time everyday.

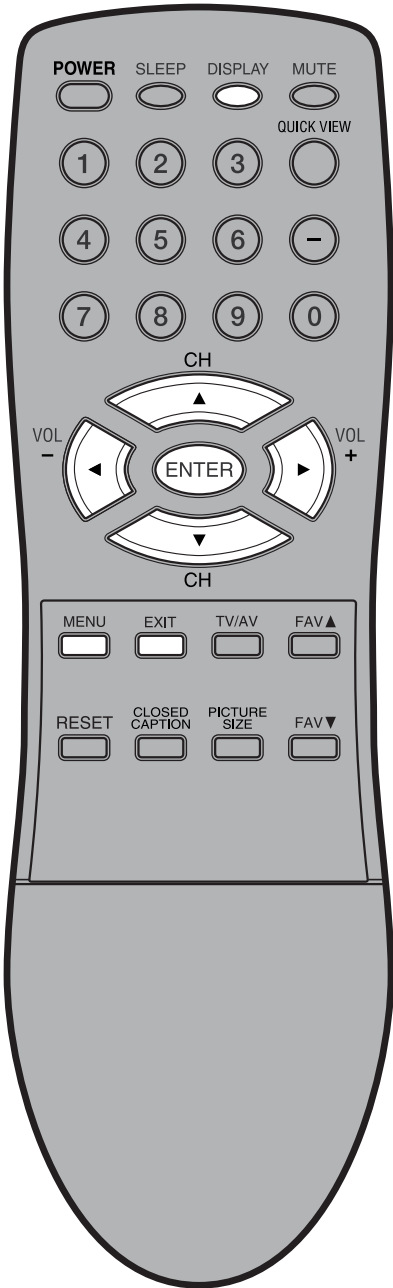

NOTES:

- If a station being viewed stops broadcasting, the TV will automatically shut itself off after 15 minutes.
- **To confirm the ON/OFF TIMER:** Press **DISPLAY** to indicate the programs on the screen.
- To return from ON/OFF TIMER menu to OPTION menu, select "OPTION MENU" then press **◀** or **▶**.

EXAMPLE: Turning off the TV at 11:30 PM, daily.

Preparation:

Set the clock, if you have not already done so (see page 28).

1 Press **MENU**. Press **◀** or **▶** to select OPTION menu. Press **▲** or **▼** to select "ON/OFF TIMER".

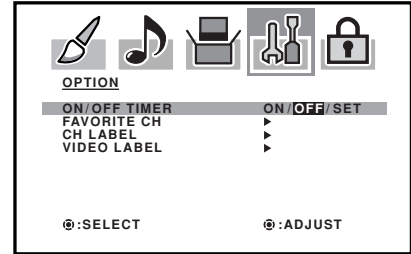

2 Press **◀** or **▶** to select "SET", then press **ENTER**. The ON/OFF TIMER menu appears.

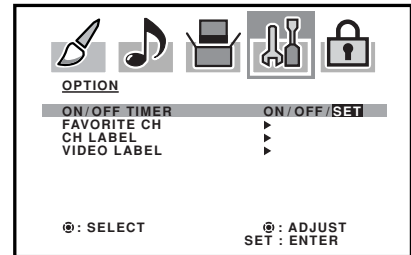

3 Press **▲** or **▼** to select "OFF TIMER", then press **▶** to enter to setting of OFF TIMER.

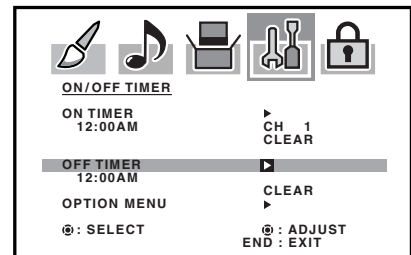

4 Press **▲** or **▼** to set the desired hour, then press **▶**. Please note if the hour is AM or PM, and choose desired setting. Press **▲** or **▼** to set the desired minutes and press **◀** or **▶** to select "DAILY", then press **ENTER**.

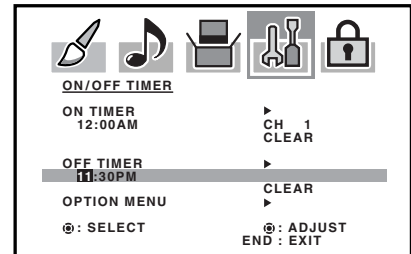

NOTE:

To cancel OFF TIMER, press **▶** to select "CLEAR" after this step, then press **ENTER**.

5 Press **EXIT** to return to normal screen.

Enable or disable the ON/OFF TIMER function

1 Press **MENU**. Press **◀** or **▶** to select OPTION menu. Press **▲** or **▼** to select "ON/OFF TIMER". Press **◀** or **▶** to select "ON" or "OFF".

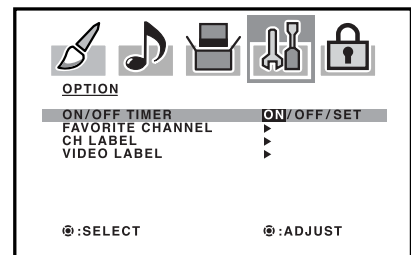

ON: Timer setting is enabled.

OFF: Timer setting is disabled.

2 Press **EXIT** to return to the normal screen.

Setting the picture size

You can view 480i and 480p format programs in a variety of picture sizes—NATURAL, CINEMA WIDE1, CINEMA WIDE2, CINEMA WIDE3, and FULL.

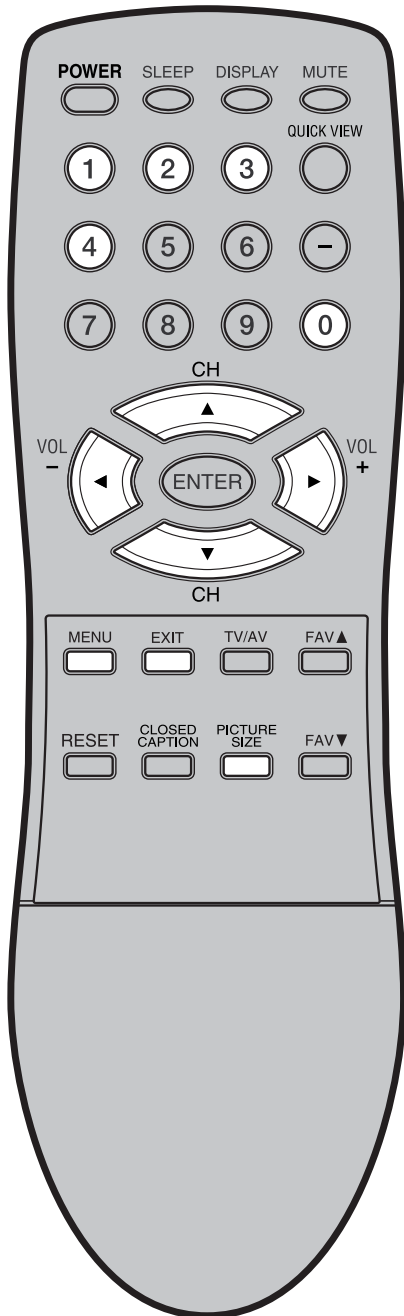

Selecting the picture size

1 Press **MENU**. Press ◀ or ▶ to select **SETUP** menu. Press ▲ or ▼ to select “**PICTURE SIZE**”.

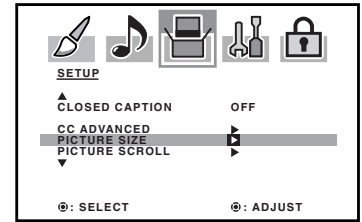

2 Press ◀ or ▶. The **PICTURE SIZE** menu will appear. Press ▲ / ▼ or a **number buttons (0-4)** to select the desired picture size, as described below and on the next page, then press **ENTER**.

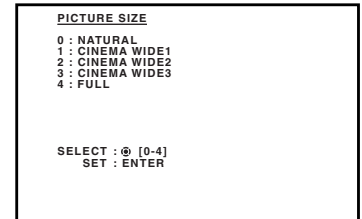

3 Press **EXIT** to return to the normal screen.

NOTE:

You can also display the **PICTURE SIZE** menu by pressing the **PICTURE SIZE** button on the remote control.

NATURAL picture size

In many cases, this image will display the size of standard 4:3 with a black side bar.

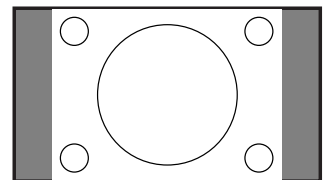

Natural picture size example

CINEMA WIDE1 picture size (for 4:3 format programs)

To fill the screen, the right and left edges are extended more widely though the center of the picture remains near former ratio.

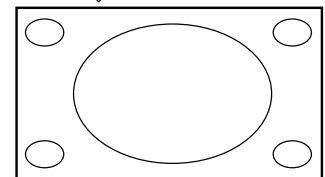
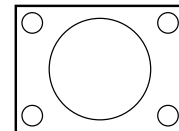

CINEMA WIDE1 picture size example

Setting the picture size

(continued)

NOTE:

The PICTURE SIZE feature is not available for some program formats (such as 1080i or 720p). Such formats will display in FULL.

CINEMA WIDE2 picture size (for letter box programs)

The entire picture is uniformly enlarged—it is stretched the same amount both wider and taller (retains its original proportion).

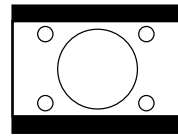

The top and bottom edges of the picture may be hidden. To view the hidden areas, it is possible to make the picture scroll (see page 33).

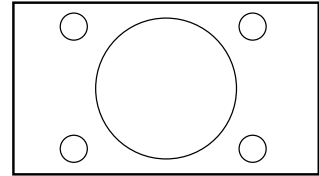

CINEMA WIDE2 picture size example

CINEMA WIDE3 picture size (for letter box programs with subtitles)

To fill the width of the screen, it is extended horizontally. However; it is only slightly extended at the top and the bottom.

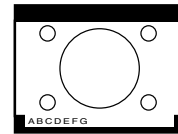

The top and bottom edges of the picture may be hidden. To view the hidden areas (such as subtitles or captions), it is possible to make the picture scroll (see page 33).

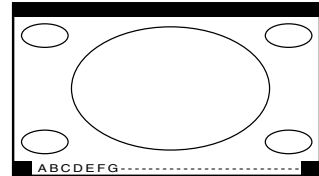

CINEMA WIDE3 picture size example

FULL picture size (for 16:9 source programs)

FULL will display the picture at the maximum size.

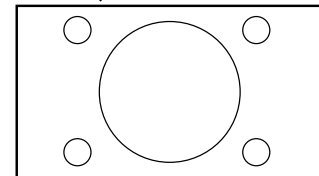
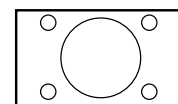

FULL picture size example

Setting the picture scroll

You can scroll the picture in CINEMA WIDE2 and CINEMA WIDE3

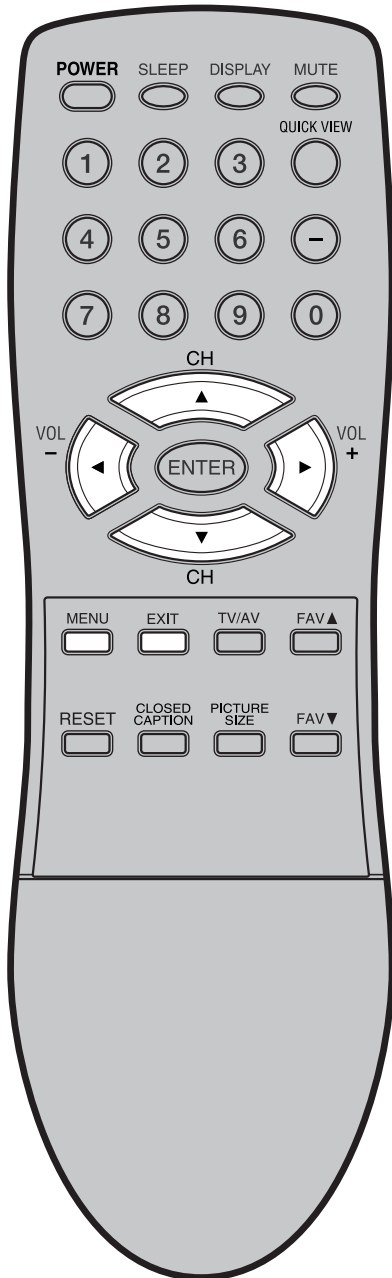

1 Press **MENU** in CINEMA WIDE2 or CINEMA WIDE3 mode. Then press ◀ or ▶ to select **SETUP** menu.

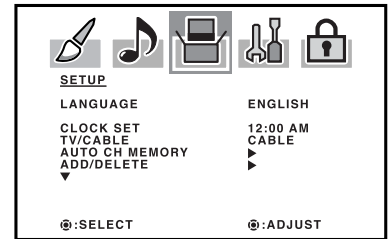

2 Press ▲ or ▼ to select "PICTURE SCROLL".

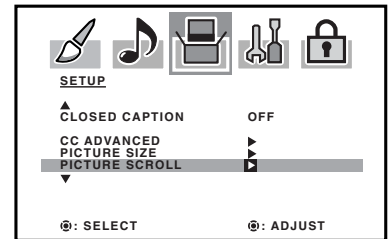

3 Press ◀ or ▶ to display the **SCROLL ADJUSTMENT** mode.

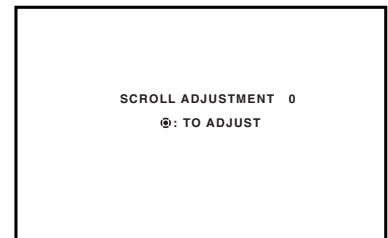

4 Press ▲ or ▼ to adjust the vertical position of the picture.

Normal (center) position

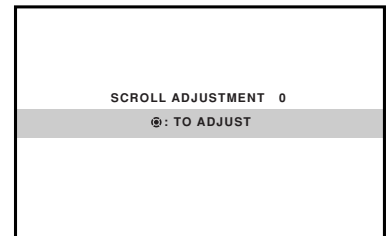

To raise the picture, press ▲.

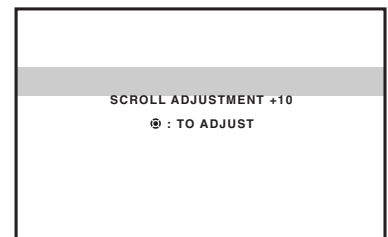

To lower the picture, press ▼.

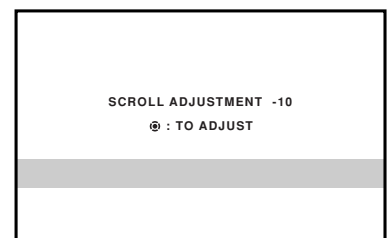

NOTE:

The scroll amounts are as follows:

- 480i/480p signal source:
 CINEMA WIDE1 : Not adjustable
 CINEMA WIDE2 : -10 to +20
 CINEMA WIDE3 : -10 to +20

5 Press **EXIT** to return to the normal screen.

Adjusting the picture preference

You can select four picture modes—SPORTS, STANDARD, MOVIE, and MEMORY—as described in the following table:

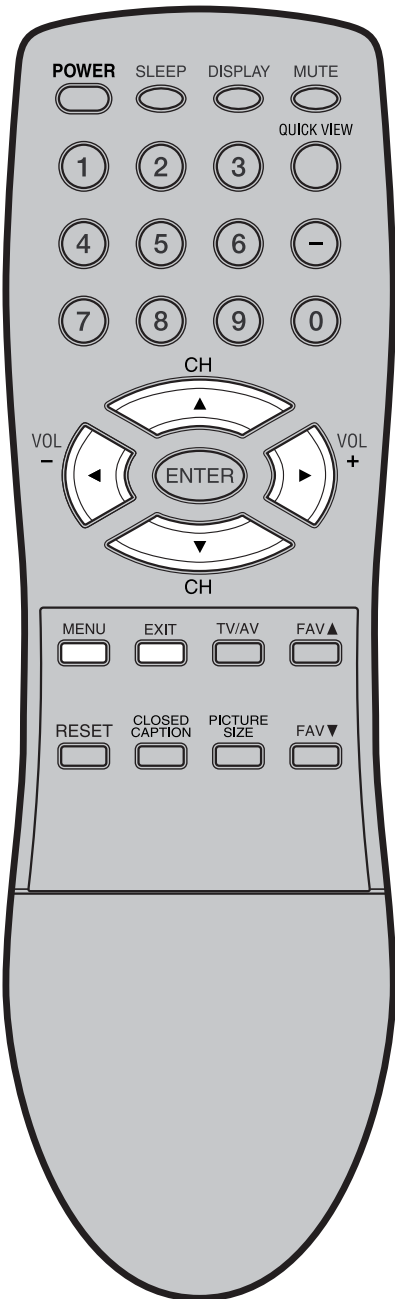

Adjusting the picture preference

1 Press **MENU**, then press ◀ or ▶ to select PICTURE menu.

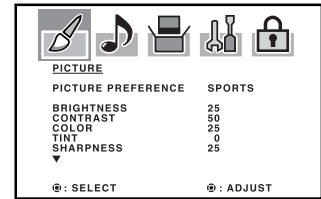

2 Press ▲ or ▼ to select "PICTURE PREFERENCE".

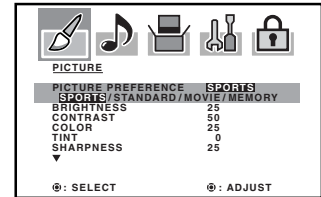

3 Press ◀ or ▶ to select the item you want to adjust.

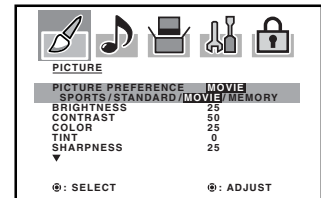

Mode	Picture Quality
SPORTS	Bright and dynamic picture (factory-set)
STANDARD	Standard picture quality (factory-set)
MOVIE	Movie-like picture setting (factory-set)
MEMORY	Your personal preferences (set by you; see "Picture control adjustment" on the next page).

4 After your desired setting, press **EXIT** to return to the normal screen.

Picture control adjustment

Picture control adjustment

- 1 Press **MENU**, then press ◀ or ▶ to select PICTURE menu.

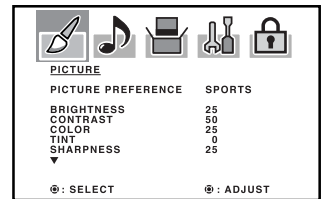

- 2 Press ▲ or ▼ to select the item you want to adjust. Press ◀ or ▶ to adjust the setting.

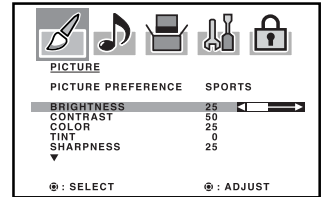

	◀	▶
BRIGHTNESS	decrease brightness	increase brightness
CONTRAST	decrease contrast	increase contrast
COLOR	paler color	brilliant color
TINT	reddish color tint	greenish color tint
SHARPNESS	makes picture softer	makes picture clearer

- 3 After your desired setting, press **EXIT** to return to normal screen.

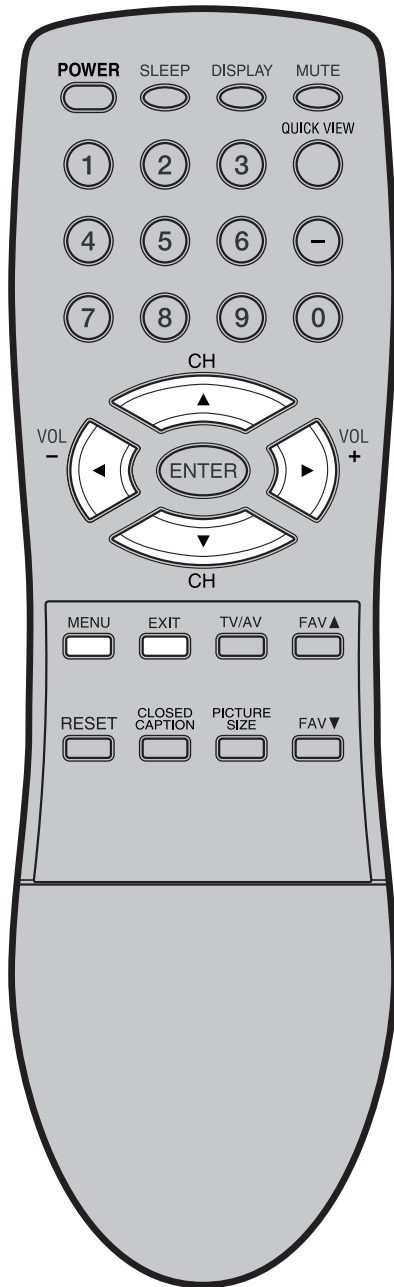

NOTE:

The **CONTRAST** default setting is set to maximum at the factory.

Selecting the color temperature/Selecting the Scan Velocity Modulation (SVM)/Resetting your picture adjustment

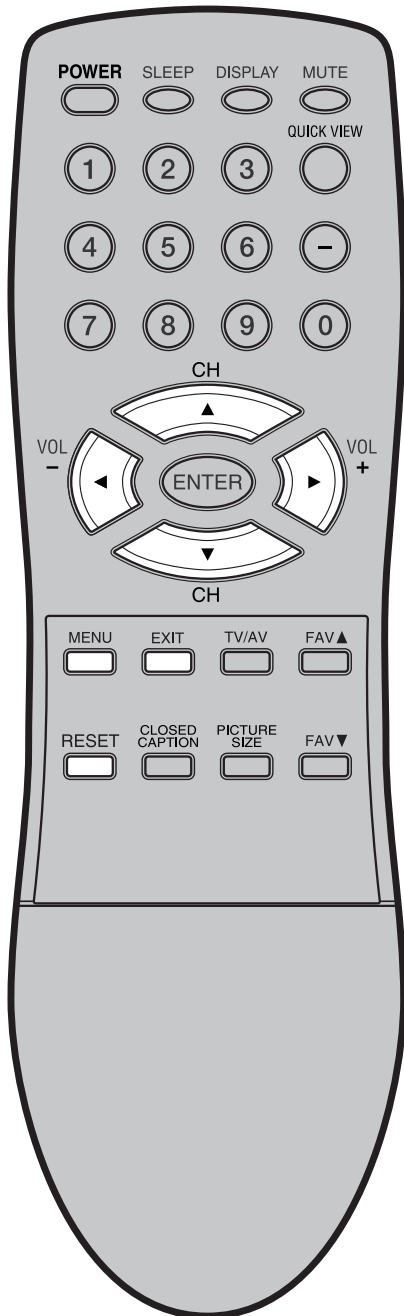

NOTE:
When you press **RESET** in the PICTURE menu, the picture adjustments return to the factory preset levels.

Selecting the color temperature

Change the picture quality by selecting from three preset color temperatures—COOL, MEDIUM, and WARM:

- 1 Press **MENU**, then press ◀ or ▶ to select PICTURE menu.
- 2 Press ▲ or ▼ to select "COLOR TEMPERATURE". Press ◀ or ▶ to select the mode you prefer.

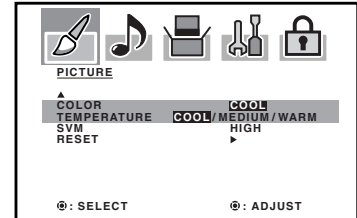

Mode	Picture Quality
COOL	Blueish
MEDIUM	Neutral
WARM	Reddish

- 3 Press **EXIT** to return to the normal screen.

Selecting the Scan Velocity Modulation (SVM)

The SVM feature enhances picture contrast and sharpness. This feature has three modes: HIGH, LOW, and OFF.

- 1 Press **MENU**, then press ◀ or ▶ to select PICTURE menu.
- 2 Press ▲ or ▼ to select "SVM".
- 3 Press ◀ or ▶ to select to "HIGH" or "LOW".
- 4 Press **EXIT** to return to the normal screen.

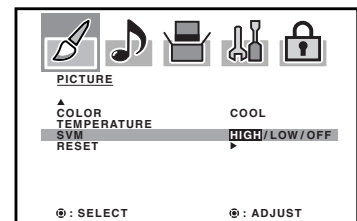

To turn off the SVM:

Select "OFF" in step 3.

Resetting your picture adjustment

The RESET function returns your picture quality adjustments to the following factory settings:

MODE sports TINT center (0)
 BRIGHTNESS center (25) SHARPNESS center (25)
 CONTRAST max (50) COLOR TEMPERATURE cool
 COLOR center (25) SVM high

- 1 Press **MENU**, then press ◀ or ▶ to select PICTURE menu.
- 2 Press ▲ or ▼ to select RESET, then press ▶.

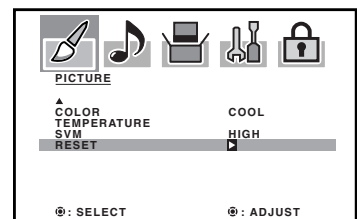

Closed Caption

WHAT IS CLOSED CAPTIONING?

This television has the capability to decode and display Closed Captioned television programs. Closed Captioning will display text on the screen for hearing impaired viewers or it will translate and display text in another language.

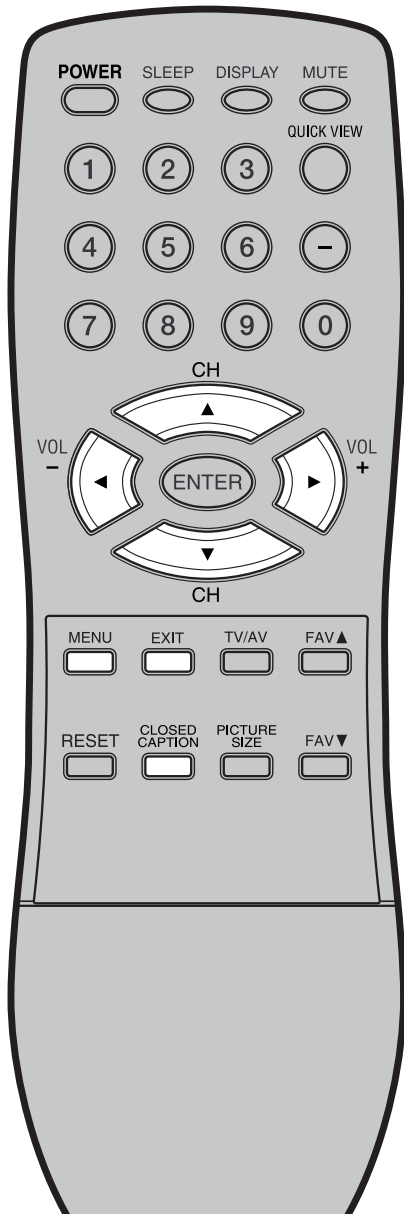

Captions: This Closed Caption Mode will display text on the screen in English or another language. Generally, Closed Captions in English are transmitted on C1 and Closed Captions in other languages are transmitted on C2.

Text: The Text Closed Caption Mode will usually fill 1/2 of the screen with a programming schedule or other information.

- 1 Tune the TV to the desired program.
- 2 Press **MENU**, then press ◀ or ▶ to display the SETUP menu.
- 3 Press ▲ or ▼ to select "CLOSED CAPTION".

When Analog signal is received, you can choose C1, C2, T1, T2 and OFF.

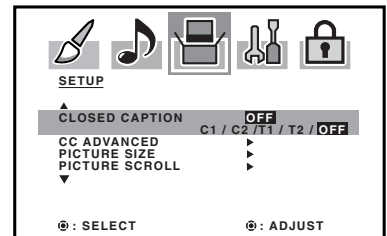

When Digital signal is received, you can choose from C1, C2, C3, C4, C5, C6 and OFF.

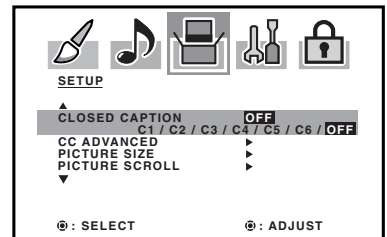

NOTES:

- Depending on the broadcast signal, some Analog Captions will function with a Digital broadcast signal.
- This screen can be displayed pushing **CLOSED CAPTION**.

- 4 Press ◀ or ▶ to select the desired Closed Caption mode.

NOTE:

To turn the Closed Caption feature off, select "OFF".

- 5 Press **EXIT** to return to the normal screen.

NOTES:

- If the program or video you selected is not closed-captioned, no captions will display on-screen.
- If text is not available in your viewing area, a black rectangle may appear on-screen. If this happens, set the Closed Caption feature to "OFF".
- When selecting Closed Captions, the captioning will be delayed approx. 10 seconds.
- If no caption signal is received, no captions will appear, but the television will remain in the Caption Mode.
- Misspellings or unusual characters may occasionally appear during Closed Captioning. This is normal with Closed Captioning, especially with live programs. This is because during live programs, captions are also entered live. These transmissions do not allow time for editing.
- When Captions are being displayed, on-screen displays, such as volume and mute may be seen but may interfere with Closed Captions.
- Some Cable TV systems and copy protection systems may interfere with the Closed Captioned signal.
- If using an indoor antenna or if TV reception is very poor, the Closed Caption Decoder may not appear or may appear with strange characters or misspelled words. In this case, adjust the antenna for better reception or use an outdoor antenna.

CC advanced

Closed Caption are factory preset but you can adjust them individually as follow:

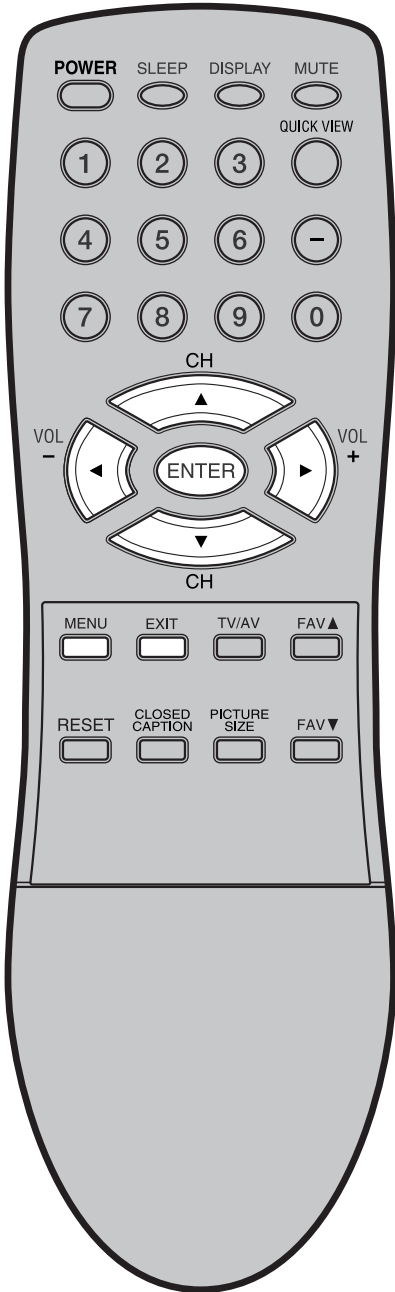

This feature is designed to customize Digital Caption only.

1 Press **MENU**. The menu screen will appear.

2 Press ◀ or ▶ to select **SETUP** menu.

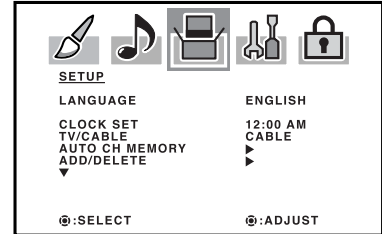

3 Press ▲ or ▼ to select “**CC ADVANCED**”, then press ▶. The **CC ADVANCED** menu will appear.

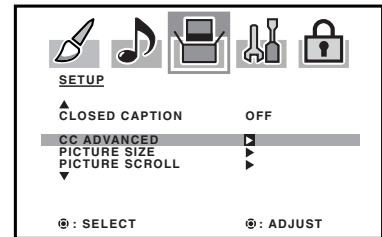

4 Press ▲ or ▼ to select the item you want to adjust, then press ◀ or ▶.

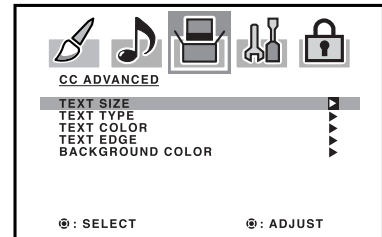

5 Press ▲ or ▼ to select desired setting, then press **ENTER**.

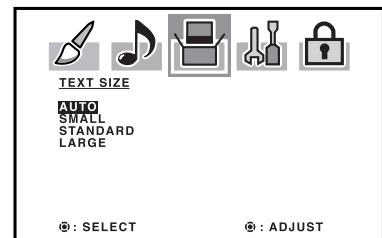

You can select from among the following items and parameters.

TEXT SIZE: AUTO, SMALL, STANDARD, LARGE

TEXT TYPE: AUTO, DEFAULT, MONO W. SERIF, PROP. W. SERIF, MONO W/O SERIF, PROP. W/O SERIF, CASUAL, CURSIVE, SMALL CAPITALS

TEXT COLOR: AUTO, BLACK, WHITE, RED, GREEN, BLUE, YELLOW, MAGENTA, CYAN

TEXT EDGE: AUTO, NONE, RAISED, DEPRESSED, UNIFORM, LEFT DROP SHADOW, RIGHT DROP SHADOW

BACKGROUND COLOR: AUTO, BLACK, WHITE, RED, GREEN, BLUE, YELLOW, MAGENTA, CYAN

6 Press **EXIT** to return to the normal screen.

Selecting stereo/Second Audio Program (SAP)/ Sound control adjustment

The multi-channel TV sound (MTS) feature provides high-fidelity stereo sound. MTS also can transmit a second audio program (SAP) containing a second language or other audio information.

When the TV receives a stereo or SAP broadcast, the word "STEREO" or "SAP" displays on-screen every time you turn the TV on, change the channel, or press DISPLAY.

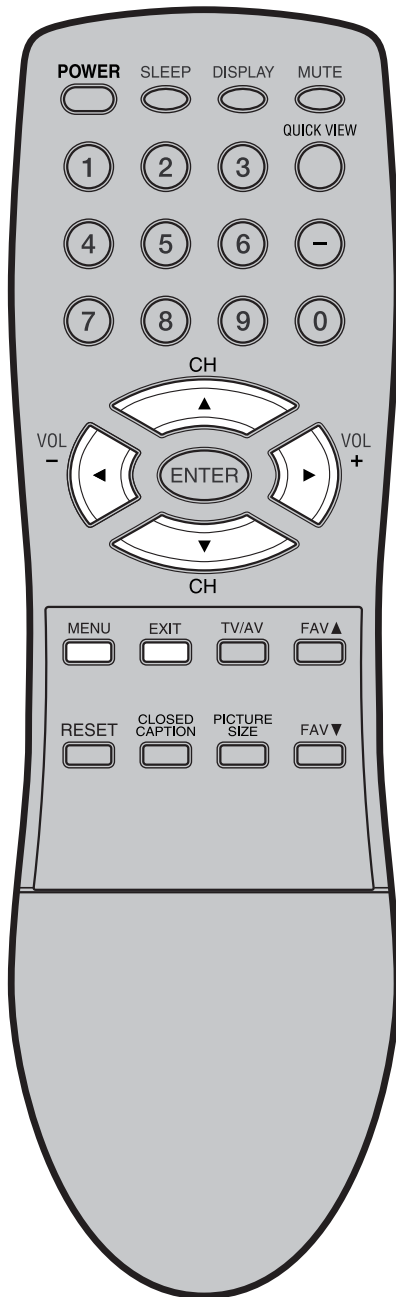

Selecting stereo/Second Audio Program (SAP)

- 1 Press **MENU**, then press ◀ or ▶ to select **AUDIO** menu. Press ▲ or ▼ to select "MTS".
- 2 Press ◀ or ▶ to select "STR (Stereo)".

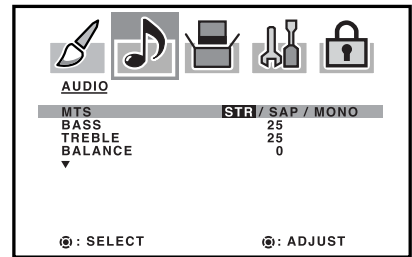

NOTES:

- In general, you can leave your TV in stereo mode because the TV automatically outputs the type of sound being broadcast (stereo or mono).
- If the stereo sound is noisy, select MONO to reduce the noise.

To listen to a second audio program (SAP)

Press ◀ or ▶ to select "SAP" in step 2 above. The TV speakers will output the second audio program instead of normal audio.

Sound control adjustment

Sound controls are factory preset but you can adjust them individually as follows:

- 1 Press **MENU**, then press ◀ or ▶ to select **AUDIO** menu.
- 2 Press ▲ or ▼ to select the item you want to adjust.

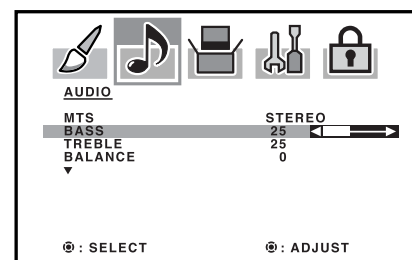
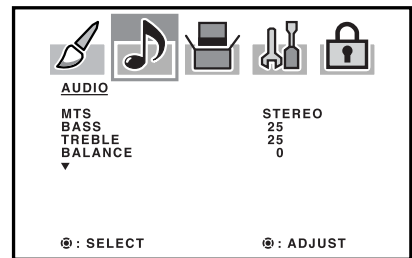

BASS:

Press ◀ or ▶ to adjust the bass sound.

TREBLE:

Press ◀ or ▶ to adjust the treble sound.

BALANCE:

Press ◀ or ▶ to obtain an equal sound level from both speakers.

- 3 After your desired setting, press **EXIT** to return to the normal screen.

Selecting the BBE/Selecting the digital output

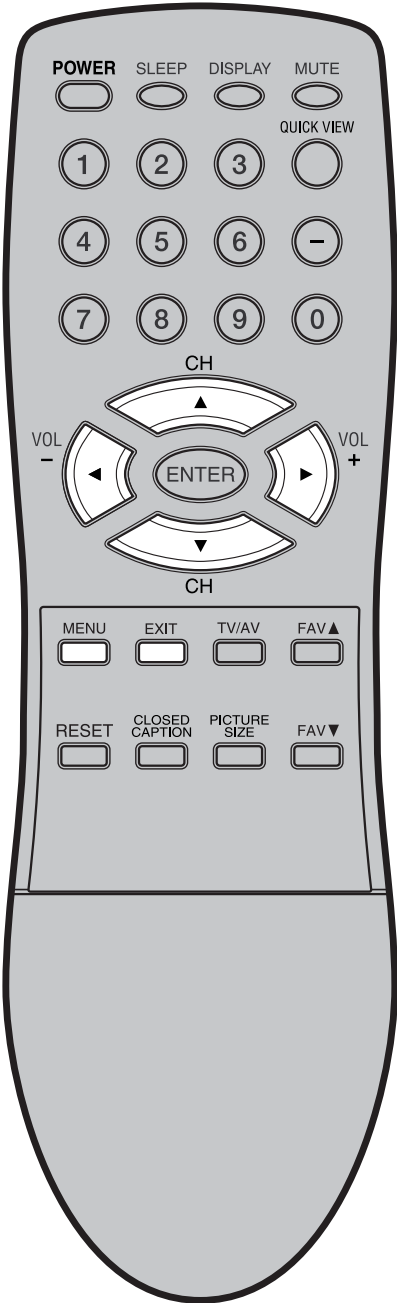

Licensed by BBE Sound, Inc. under USP, 5510752 and 5736897. BBE and BBE symbol are registered trademarks of BBE Sound, Inc.

Selecting the BBE

By correcting the phase delay and distortion naturally generated by speaker systems, the BBE sound feature ensures that the sound that reaches your ears is as natural as the original sound. Human voices are clearer and music is natural and well-defined.

- 1 Press **MENU**, then press ◀ or ▶ to select AUDIO menu.

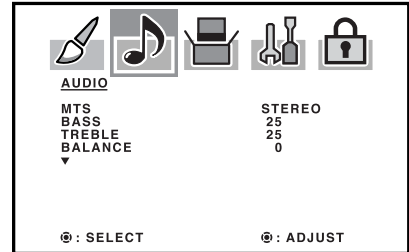

- 2 Press ▲ or ▼ to select "BBE", then press ◀ or ▶ to select "ON".

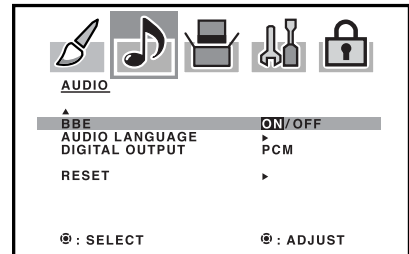

- 3 Press **EXIT** to return to the normal screen.

To turn off the BBE sound feature:

Select "OFF" in step 2 above.

Selecting the digital output

You can choose the format of the digital audio output signal.

- 1 Press **MENU**, then press ◀ or ▶ to select AUDIO menu. Press ▲ or ▼ to select "DIGITAL OUTPUT".

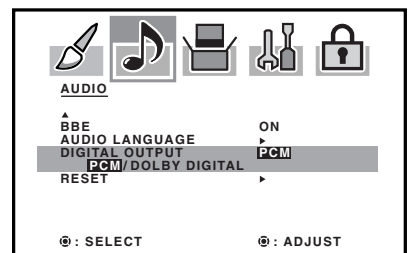

- 2 Press ◀ or ▶ to select "PCM" or "DOLBY DIGITAL".

- 3 Press **EXIT** to return to the normal screen.

Selecting the audio language/Resetting your audio adjustments

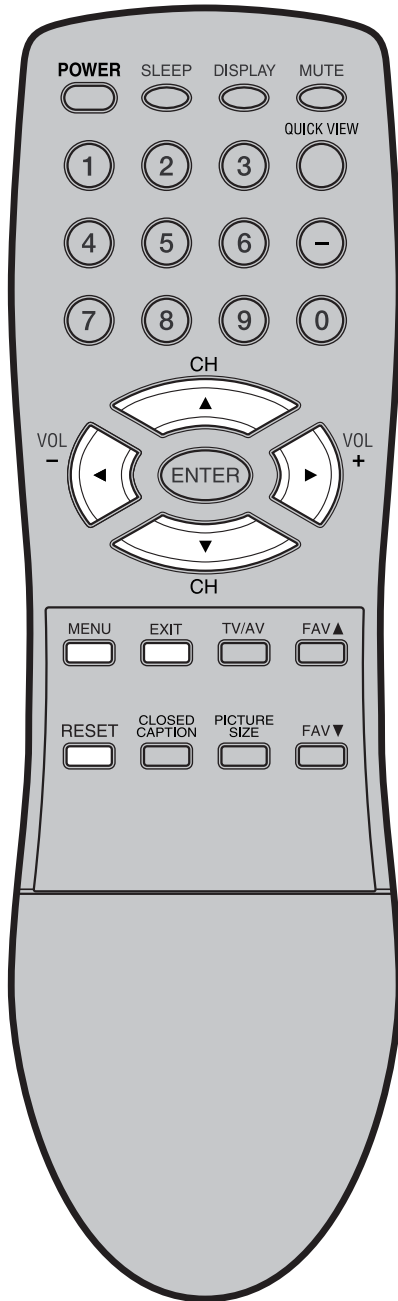

NOTE:
When you press **RESET** in the AUDIO menu, the audio adjustments return to the factory preset levels.

Selecting the audio language

When two or more audio languages are included in a digital signal, you can select one of the audio language.

- 1 Press **MENU**, then press ◀ or ▶ to select AUDIO menu.

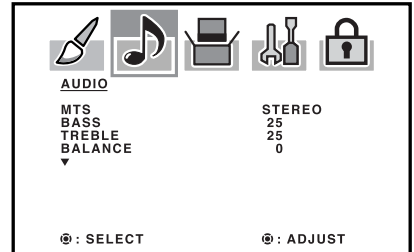

- 2 Press ▲ or ▼ to select "AUDIO LANGUAGE". Then press ◀ or ▶ to display the AUDIO LANGUAGE menu.

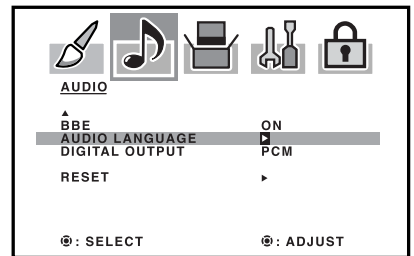

- 3 Press ▲ or ▼ to select your desired language, then press **ENTER**.

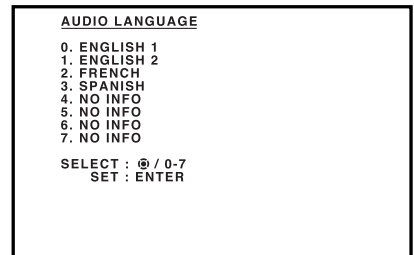

- 4 Press **EXIT** to return to the normal screen.

Resetting your audio adjustments

The RESET function returns the audio adjustments to the following factory settings:

BASS center (25)
TREBLE center (25)
BALANCE center (0)

- 1 Press **MENU**, then press ◀ or ▶ to select AUDIO menu.

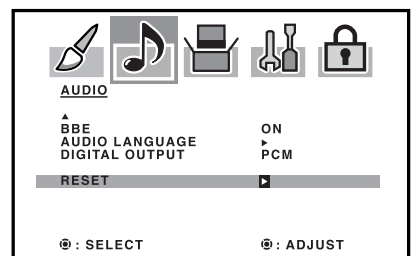

- 2 Press ▲ or ▼ to select "RESET", then press ▶.

Checking the Digital-signal strength

You can view the digital signal meter.

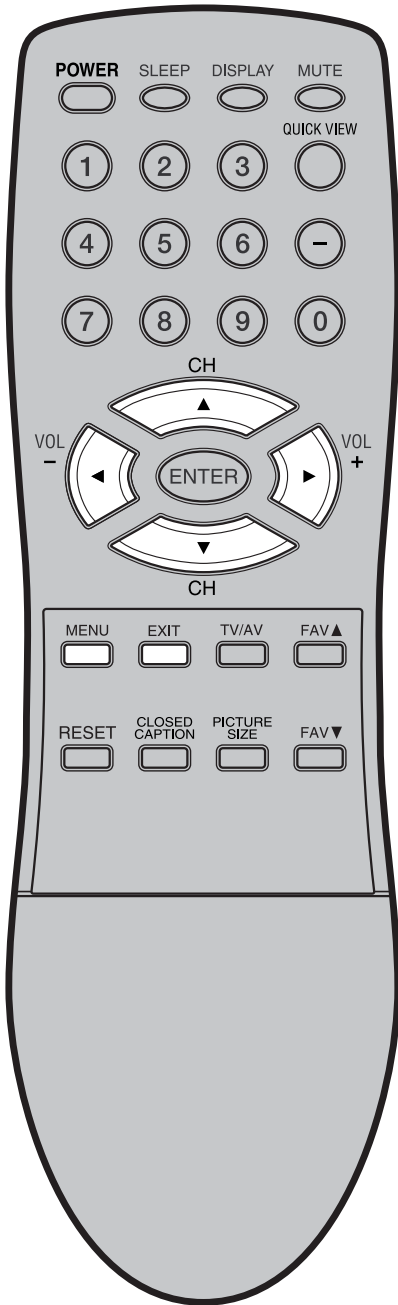

1 Press **MENU**, then press ◀ or ▶ to select **SETUP** menu.

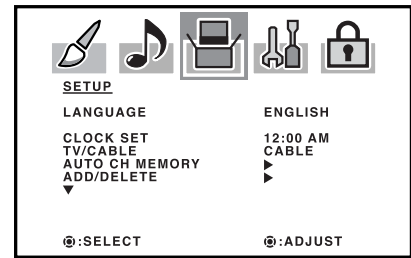

2 Press ▲ or ▼ to select "SIGNAL METER".

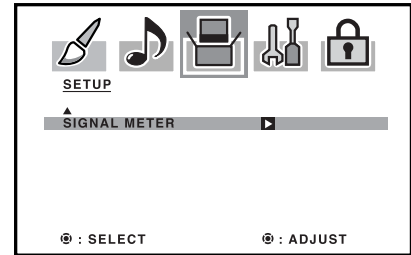

3 Press ◀ or ▶ to check the Digital-signal strength.

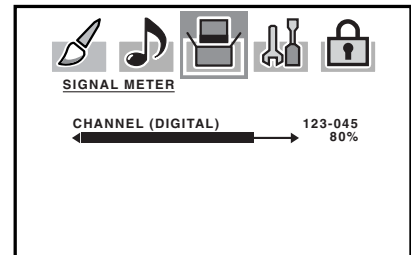

4 Press **EXIT** to return to the normal screen.

NOTES:

- Signal meter feature is not available for analog channels.
- After 240 seconds, SIGNAL METER screen will return to normal TV-operation automatically.

Troubleshooting

Use the following check list for troubleshooting when you have problems with your TV. Consult your local dealer or service outlet if problems persist. Be sure all connections are properly made when using with other units.

SYMPTOMS	POSSIBLE SOLUTIONS	SYMPTOMS	POSSIBLE SOLUTIONS
TV does not operate.	<ul style="list-style-type: none"> • Make sure the power cord is plugged in. • Try another AC outlet. • Power is off, check fuse or circuit breaker. • Unplug unit for an hour, then plug it back in. 	No CATV reception.	<ul style="list-style-type: none"> • Check all CABLE connections. • Set TV/CABLE menu option to the CABLE mode. • Station or CABLE system problems, try another station.
Poor sound or no sound.	<ul style="list-style-type: none"> • Station or CABLE experiencing problems, tune to another station. • Check sound adjustments (Volume and Mute). • Check for sources of possible interference. 	Horizontal or diagonal bars on screen.	<ul style="list-style-type: none"> • Check antenna connections, adjust or re-direct antenna. • Check for sources of possible interference.
Poor picture or no picture.	<ul style="list-style-type: none"> • Station or CABLE experiencing problems, tune to another station. • Make sure channels are set into memory. • Check antenna or CABLE connections, adjust antenna. • Check for sources of possible interference. • Check picture control adjustments. 	No reception above channel 13.	<ul style="list-style-type: none"> • Make sure TV/CABLE menu option is in the appropriate mode. • If using antenna, check UHF antenna connections.
Poor reception on some channels.	<ul style="list-style-type: none"> • Station or CABLE experiencing problems, tune to another station. • Make sure channels are set into memory. • Station is weak, adjust antenna to receive desired station. • Check for sources of possible interference. 	No Remote operation.	<ul style="list-style-type: none"> • Batteries are weak, dead or inserted incorrectly. • Remote is out of range, move closer to TV (within 15 feet). • Make sure Remote is aimed at sensor. • Confirm there are no obstructions between the Remote and the TV. • Make sure the power cord is plugged in.
Poor color or no color.	<ul style="list-style-type: none"> • Station or CABLE experiencing problems, tune to another station. • Make sure channels are set into memory. • Check picture control adjustments. • Check antenna or CABLE connections, adjust antenna. • Check for sources of possible interference. 	TV shuts off.	<ul style="list-style-type: none"> • No broadcast on station tuned. • Sleep Timer is set. • Power interrupted.
Picture wobbles or drifts.	<ul style="list-style-type: none"> • Station or CABLE experiencing problems, tune to another station. • Make sure channels are set into memory. • CABLE company is scrambling signal. • Adjust antenna. 	Closed - Caption is not activated.	<ul style="list-style-type: none"> • TV station experiencing problems or program tuned is not closed captioned. Try another channel. • Check CABLE connection or VHF/UHF antenna, reposition or rotate antenna. • Set closed caption decoder in the menu.
Digital broadcast-ing screen problem.	<ul style="list-style-type: none"> • Check digital signal strength. 	Display is not shown in your language.	<ul style="list-style-type: none"> • Select proper language in the menu options.

FOR CUSTOMER SERVICE,
ADDITIONAL SET-UP OR
OPERATING ASSISTANCE
PLEASE CALL:

1-800-289-0980

WHEN CALLING CUSTOMER SERVICE – PLEASE HAVE YOUR MODEL NUMBER READY



TO ORDER ACCESSORY
PARTS OR LITERATURE

PLEASE CALL:

1-888-369-0304

OR WRITE TO:
ORION SALES, INC.
3471 N. UNION DR.
OLNEY, ILLINOIS 62450

FOR INFORMATION ON OUR OTHER PRODUCTS, PLEASE VISIT OUR WEBSITE AT
www.orionsalesinc.com

Specifications

Power supply:	AC 120 V 60 Hz
Power consumption:	Operation: 185 W Stand by: 1 W
Weight:	82.0 lbs (37.2 kg)
Dimensions:	Width: 29-15/16 inches (760 mm) Height: 19-1/8 inches (485 mm) Depth: 19-7/16 inches (493 mm)
Inputs:	VIDEO: 1 V (p-p)/75 ohms AUDIO: -8 dBm/50k ohms S-VIDEO: Y: 1 V (p-p), 75 ohms C: 0.286 V (p-p), 75 ohms COMPONENT: Y: 1 V (p-p), 75 ohms Pr: 0.7 V (p-p), 75 ohms Pb: 0.7 V (p-p), 75 ohms
Output:	VIDEO: 1 V (p-p)/75 ohms AUDIO: 150 mV (rms)
Antenna input:	VHF/UHF In 75 ohm coaxial
Picture tube:	26 inches (656.7 mm diagonal)
Tuner type:	Quartz PLL Frequency Synthesized
Receiving channels:	VHF 2-13 UHF 14-69 CABLE TV 14-36 (A)-(W) 37-59 (AA)-(WW) 60-85 (AAA)-(ZZZ) 86-94 (86)-(94) 95-99 (A-5)-(A-1) 100-125 (100)-(125) 01 (5A)
Speaker:	2 inches (51 mm) x 4-11/16 inches (119 mm), 8 ohm x 2
Sound output power:	5.0 W + 5.0 W
ACCESSORY:	Remote control x 1

Design and specifications are subject to change without notice.



LIMITED WARRANTY

26" WIDE FLAT DIGITAL TELEVISION

ORION warrants this product to be free from manufacturing defects in material and workmanship under normal use and conditions for a period of ninety (90) days from date of original purchase in the United States only.

Should service be necessary under this warranty for any reason due to a manufacturing defect or malfunction during the first ninety (90) days period from date of original purchase, ORION will provide carry-in repair service at an ORION authorized Independent Service Center at no charge. Also, if an original part fails due to manufacturing defect in material and workmanship within one year from the original date of purchase we will replace the defective part only (EXCLUDING LABOR AFTER INITIAL NINETY (90) DAYS WARRANTY PERIOD) provided the defect or malfunction is verified along with dated proof of purchase.

There are ORION Authorized Independent Service Centers located throughout the country. For the one nearest you, DIAL TOLL FREE: 1-800-289-0980 or visit our website at www.orionsalesinc.com. This product is eligible for CARRY-IN service only. ORION will not be liable for damages incurred in shipment of the unit. If there are no ORION authorized Independent Service Centers in your area please call – 1-888-296-7466 for assistance.

Note: This warranty is void if the product is:

- (a) Damaged through negligence, misuse, abuse, or accident.
- (b) Used in a commercial application or rentals.
- (c) Modified or repaired by anyone other than an ORION Independent Service Center authorized by ORION to effect warranty repairs to the class of product or by the ORION Factory Service Center.
- (d) Damaged because it is improperly connected to the equipment of other manufacturers.

This warranty does not cover:

- (a) Damage to video disc.
- (b) Damage to equipment not properly connected to the product.
- (c) Costs incurred in the shipping of the product to an authorized Independent Service Center or ORION Factory Service Center.
- (d) Damage or improper operation of unit caused by customer abuse, misuse, negligence, or failure to follow operating instructions provided with the product.
- (e) Ordinary adjustments to the product which can be performed by customer as outlined in the owner's manual.
- (f) Signal reception problems caused by external antenna or cable systems.

THIS WARRANTY IS NON-TRANSFERABLE AND APPLIES ONLY TO THE ORIGINAL PURCHASER AND DOES NOT EXTEND TO SUBSEQUENT OWNERS OF THE PRODUCT. ANY APPLICABLE IMPLIED WARRANTIES, INCLUDING THE WARRANTY OF MERCHANTABILITY, ARE LIMITED IN DURATION TO A PERIOD OF THE EXPRESS WARRANTY AS PROVIDED HEREIN BEGINNING WITH THE DATE OF ORIGINAL PURCHASE AT RETAIL AND NO WARRANTIES, WHETHER EXPRESS OR IMPLIED, SHALL APPLY TO THIS PRODUCT THEREAFTER. ORION MAKES NO WARRANTY AS TO THE FITNESS OF THE PRODUCT FOR ANY PARTICULAR PURPOSE AND USE.

UNDER NO CIRCUMSTANCES SHALL ORION BE LIABLE FOR ANY LOSS, DIRECT, INDIRECT, INCIDENTAL, SPECIAL, OR CONSEQUENTIAL DAMAGE ARISING OUT OF OR IN CONNECTION WITH THE USE OF THIS PRODUCT.

THIS WARRANTY IS VALID ONLY IN THE UNITED STATES OF AMERICA. THIS WARRANTY GIVES YOU SPECIFIC LEGAL RIGHTS, HOWEVER, YOU MAY HAVE OTHER RIGHTS WHICH MAY VARY FROM STATE TO STATE. SOME STATES DO NOT ALLOW LIMITATION ON IMPLIED WARRANTIES OR EXCLUSION OF CONSEQUENTIAL DAMAGE, THEREFORE, THESE RESTRICTIONS MAY NOT APPLY TO YOU.

ORION SALES, INC.
3471 N. UNION DR.
OLNEY, ILLINOIS 62450

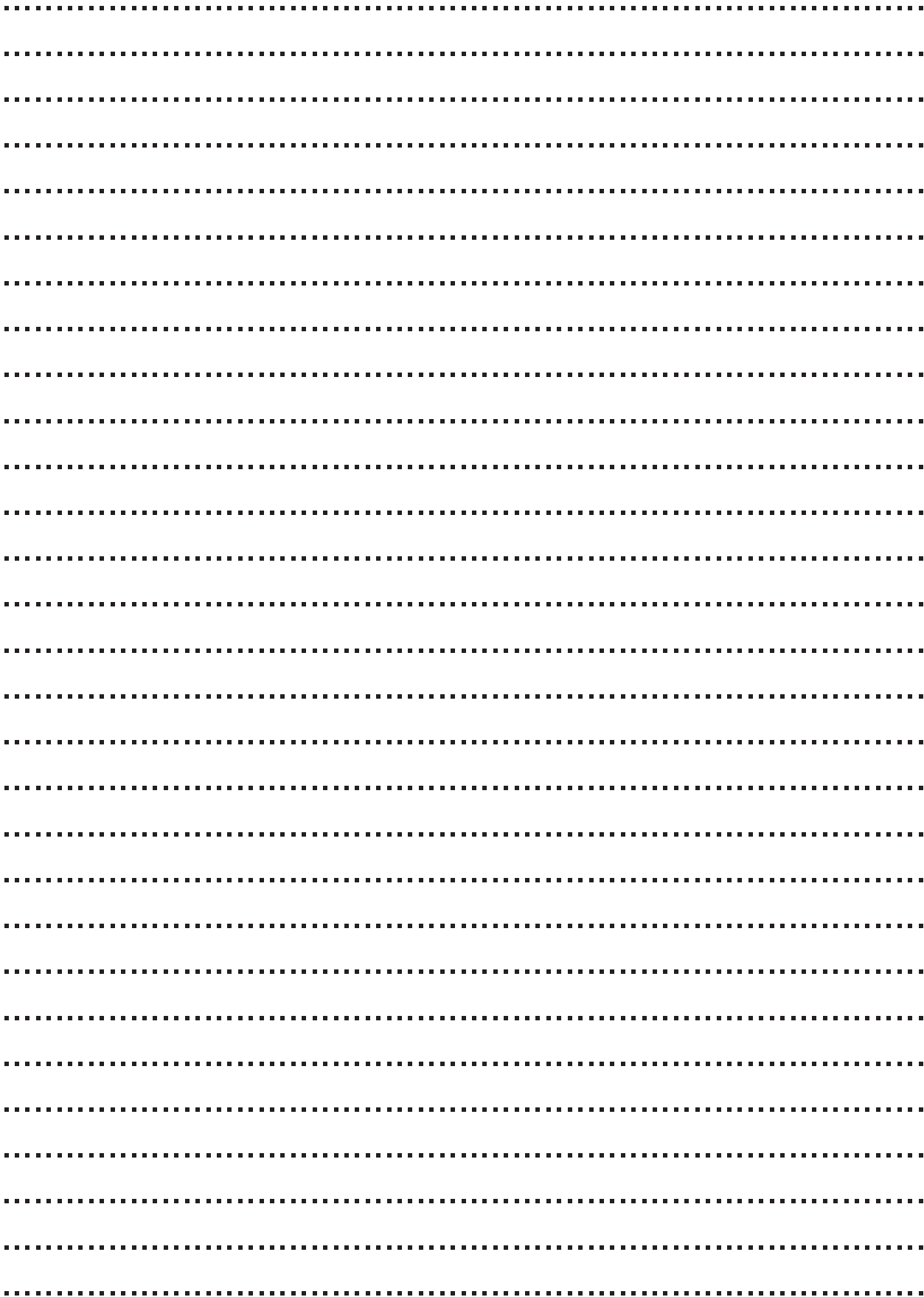



J3R90101C SH 05/05 𠄎

Printed in Thailand